

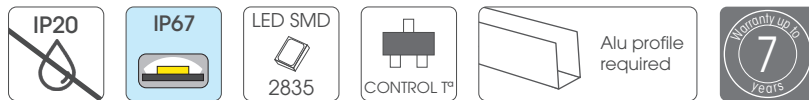

Led Strips Professional Series

CCTX-2835-XX-002(W)X

Dimmable LED strip with temperature control
SMD2835 - 120Leds/meter



Features

New PCB with ADF Technology, 50% thicker than previous one to improve cooling rating.
Improved circuit desing with constant current and temperature control to get better lifespan.

High Performance LM80 certified 2835 type leds.

It allows the cutting by groups to facilitate its use.

Uniform brightness throughout its entire length.

24VDC power supply to get better reliability

“SDCM 3” MacAdam selection “step3”

Highest performance original 3M VHB back adhesive tape.

CRI>83 standard rate.

CRI>97 optional rate under request.

CE, LVD & EMC European certificates available.

* LM80 CERTIFIED:
LED LIFESPAN tested under LM80;
Expected LIFETIME of 30,000h.

CCTX-2835-XX-002(W)X

Professional series



Dimmable LED strip with temperature control

120 Led/m	11 W/m	24V	Warranty up to 7 Years
≤1600 lm/m	≤145 lm/w	LED SMD 2835	MacAdam 3 level SDCM BIN1
standard CRI >83	optional CRI >97	CONTROL™	

White color temperature range

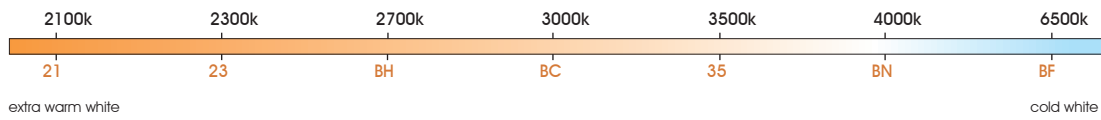

10 Max. meters in series (one side powered)	VHB 3M	driver NOT included	120°	5m	8,33mm	5cm	30.000 h
20 Max. meters in series (two side powered)	ADF PCB	Do not blend	ESD	Dimmable	Alu profile required	Working 50°C / -20°C	Storage 60°C / -40°C

Feature

Part number	CCT/ wavelength	Luminous intensity per m/flux	Efficiency (lm/W)	Ordinary strip	Strip with waterproof part number "W" suffix
CCTX-2835-21-002(W)X	±2050~2150k	±1385lm	±125		
CCTX-2835-23-002(W)X	±2250~2350k	±1420lm	±130		
CCTX-2835-BH-002(W)X	±2700~2800k	±1450lm	±132		
CCTX-2835-BC-002(W)X	±2950~3100k	±1475lm	±134		
CCTX-2835-BN-002(W)X	±3900~4050k	±1540lm	±140		
CCTX-2835-BF-002(W)X	±6400~6600k	±1600lm	±145	 5000mm 1,25mm 10mm	 5000mm 4mm 12mm No color temperature deviation

Notes

Waterproof led strips covered by silicone material use to suffer an unavoidable CCT value modification owing to optical effect caused when light beam passes through material.
Initial CCT values are increased several hundreds or thousands of °K. This increasing is much higher in coldest white CCTs. New FULLWAT molded silicone system avoids this effect and our waterproof led strips are CCT rated at original value without modification.
Please, contact with your local sales office to get wider details.

25m
25 length models are available.

50m
50 length models are available under request. Contact to our Sales Department.

Specific parameters

Reference	Waterproof materials	Size (mm)	Connections	Mode of fixation	IP rate
CCTX-2835-BF-002X	Non waterproof	10x1.25	Silicone wire red and white	Adhesive 3M VHB	IP20
CCTX-2835-BF-002WX	Silicone extruded tube	12x4	5.5mm DC connector	Adhesive 3M VHB	IP67

Bending grades

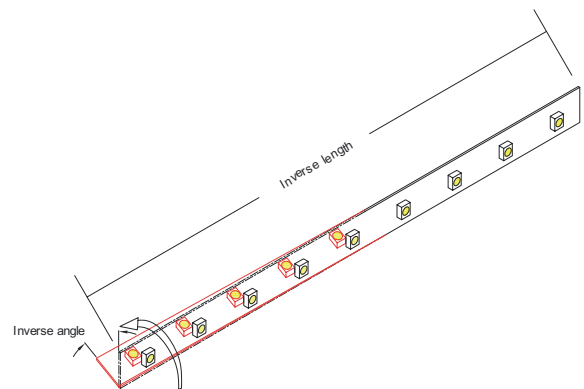
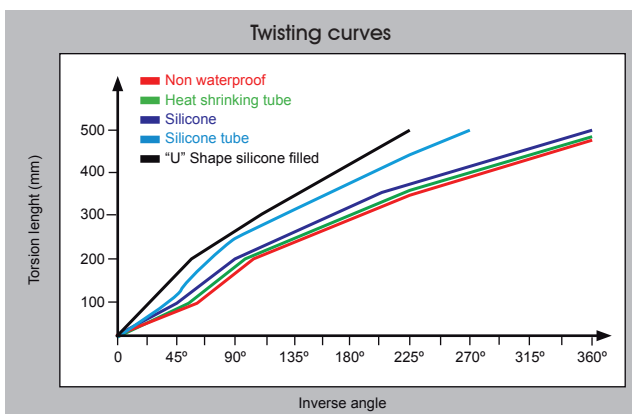
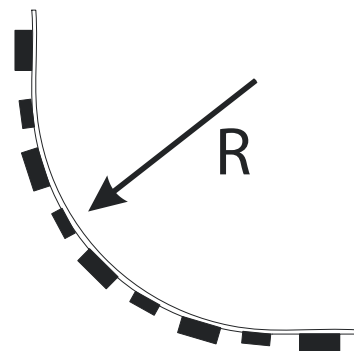
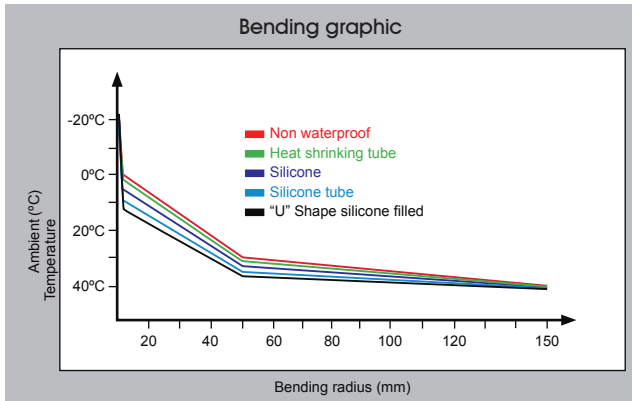

Reference point: strip bending at 0°C.

NON-WATERPROOF MODEL

Features

- IP20 easier assembling 3M VHB.
- Small in size, light in weight, flexible.



Optional accesories

ACC10-PLUG-I



ACC10-PLUG-L



ACC10-PLUG-T



ACC10-PLUG-T



Operation specification

<p>Cut in specific location</p>	<p>Put th PCB in the space between clip and connector, make the clips exactly aim at welding point</p>	<p>Close the cover of connector</p>
---------------------------------	--	-------------------------------------

Product size

Front view

Units: mm

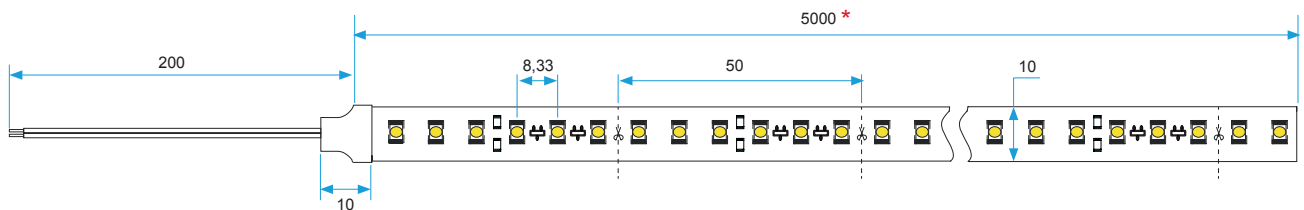

Size view

Units: mm

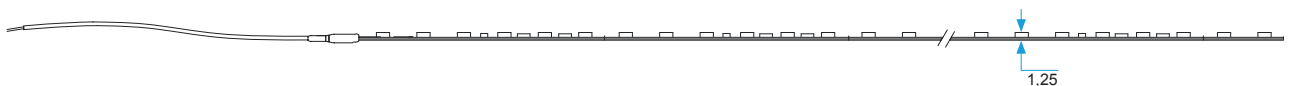

* 25 length models are available for references CCTX-2835-XX-002X/25.
50 length models are available for references CCTX-2835-XX-002X/50.

WATERPROOF MODEL

Features

- IP67 Rating with high performance molded silicone.
- High temperature, maximum flexibility, anti-UV, non toxic and improved optical transmittance >92%
- **New waterproof molded silicone system** to avoid CCT (color temperature) values modifications. Improved soldering pads in every cutting areas.



Optional accessories

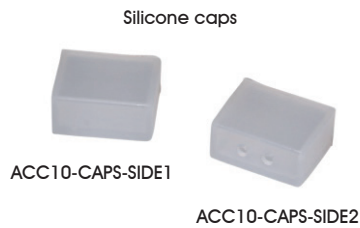

Operation specification

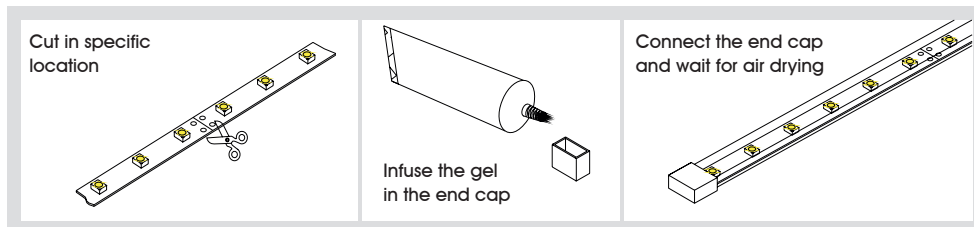

Product size

Front view

Units: mm

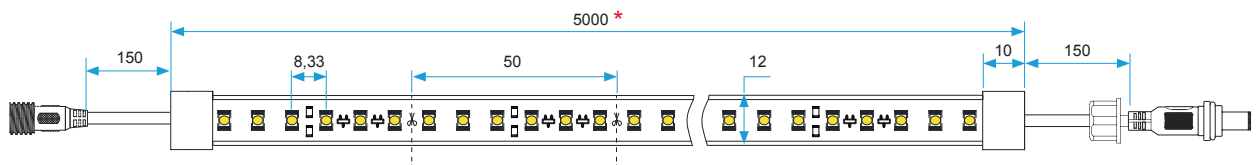

Side view

Units: mm

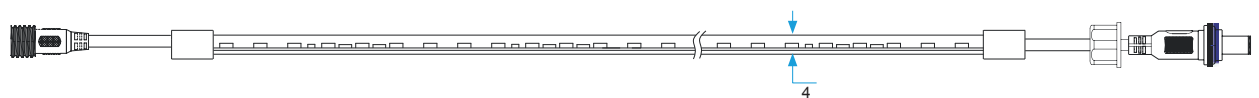

* 25 length models are available for references CCTX-2835-XX-002X/25.
50 length models are available for references CCTX-2835-XX-002X/50.

CONNECTION DIAGRAMS

Non dimmable option

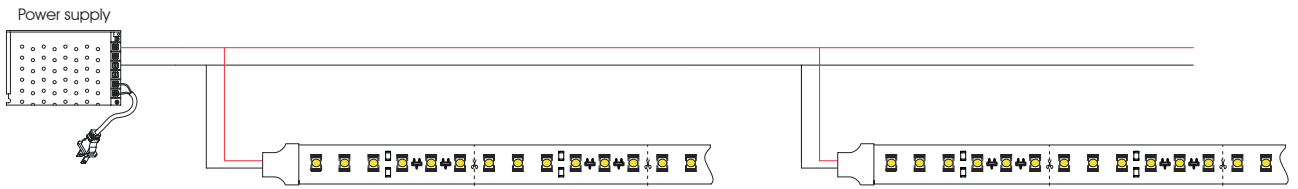

Dimmable option

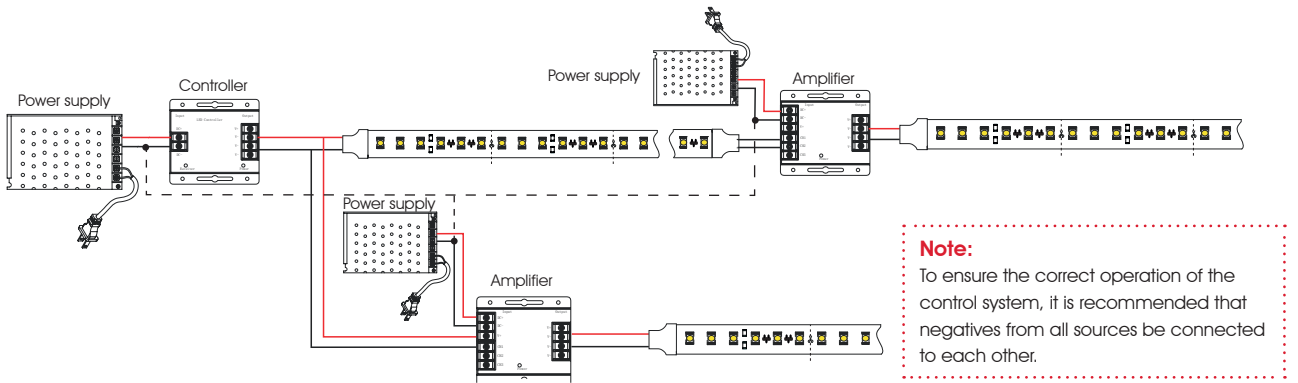

Note:
To ensure the correct operation of the control system, it is recommended that negatives from all sources be connected to each other.

INSTALLATION

Adhesive 3M VHB

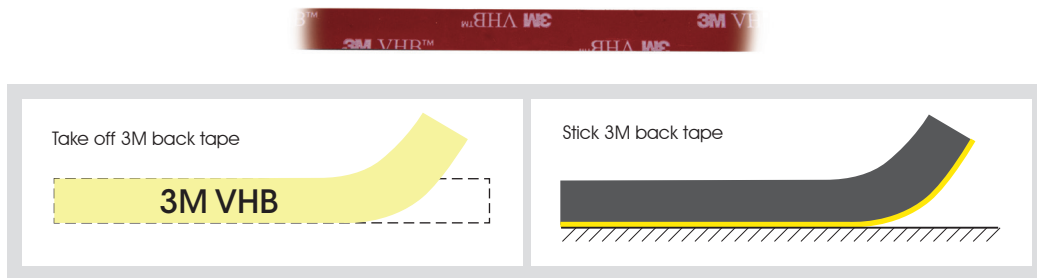

PACKAGING

