



Led Strips Professional Series

CCTX-2835F-XX-(W)X

Dimmable LED strip with temperature control
SMD2835 - 98Leds/meter



Features

New PCB with ADF Technology, 50% thicker than previous one to improve cooling rating.
Improved circuit desing with constant current and temperature control to get better lifespan.

High Performance LM80 certified 2835 LEDs.

Cutting by groups to facilitate its use.

Uniform brightness throughout entire length.

Constant current design to extend useful life

24VDC power supply to get better reliability

"SDCM 3" MacAdam selection "step3"

Highest performance original 3M VHB back adhesive tape.

CRI>98 standard rate.

CE, LVD & EMC European certificates available.

* LM80 CERTIFIED:
LED LIFESPAN tested under LM80;
Expected LIFETIME of 30,000h.



98 Led/m	14 W/m	24V	7 Years
≤1225 lm/m	LED SMD 2835	MacAdam 3 level SDCM BIN1	CONTROL T [®]
CRI >98 special	Sun spectrum	NO blue hazard	R9 >90

White color temperature range

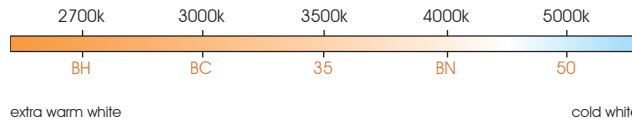

10 Max. meters in series (one side powered)	VHB 3M	driver NOT included	120°	5m	10,20mm	7,14cm	30.000 h
20 Max. meters in series (two side powered)	ADF PCB	Do not bend	ESD	Dimmable	HIGH POWER Alu profile required	Working 50°C -20°C	Storage 60°C -40°C

Features

Part number	CCT / wavelength	Luminous intensity per m / flux	Efficiency lm / W	Energy efficiency	Ordinary strip	Strip with waterproof part number "W" suffix
CCTX-2835F-BH-(W)X	±2700~2900k	±1080lm	±77	G		
CCTX-2835F-BC-(W)X	±3000~3200k	±1155lm	±83	F		
CCTX-2835F-35-(W)X ^(*)	±3500~3750k	±1110lm	±79	F		
CCTX-2835F-BN-(W)X	±4000~4500k	±1225lm	±88	F		No color temperature deviation.
CCTX-2835F-50-(W)X ^(*)	±5000~5500k	±1225lm	±88	F		No color temperature deviation.

Notes

^(*) - Solo disponible bajo pedido.

Waterproof led strips covered by silicone material use to suffer an unavoidable CCT value modification owing to optical effect caused when light beam passes silicone material. Initial CCT values are increased several hundreds or thousands of °K. This increasing is much higher in coldest white CCTs. New FULLWAT molded silicone system avoids this effect and our waterproof led strips are CCT rated at original value without modification. Luminances in the case of CR197 LED strips are reduced by about 10% compared to the values declared for CR183 LED strips. Please, contact with your local sales office to get wider details.

25m
25 length models are available.

50m
50 length models are available under request. Contact to our Sales Department.

Specific parameters

Reference	Waterproof materials	Size (mm)	Connections	Mode of fixation	IP rate
CCTX-2835F-XX)-X	Non waterproof	10x1.25	Silicone wire red and white	Adhesive 3M VHB	IP20
CCTX-2835F-XX)-WX	Silicone extruded tube	12x4	5.5mm DC connector	Adhesive 3M VHB	IP67

Bending grades

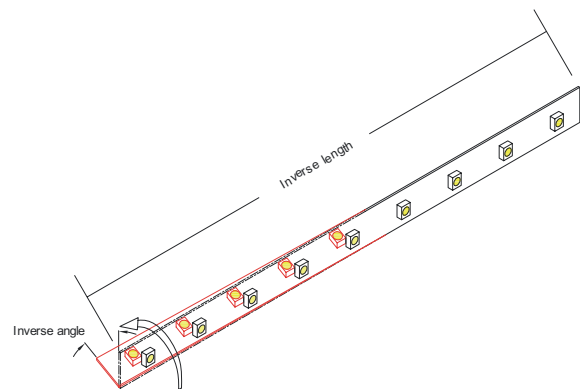
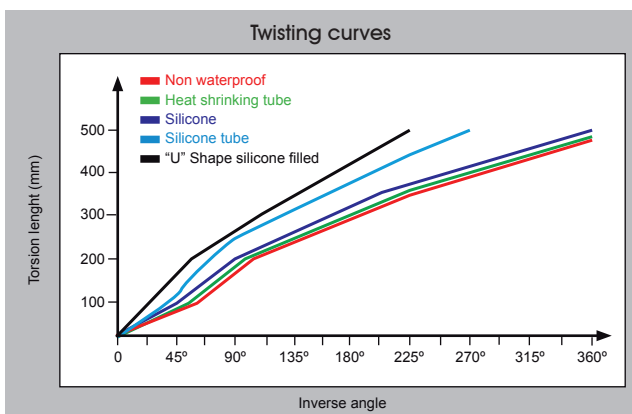
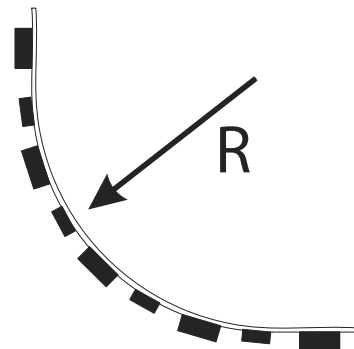
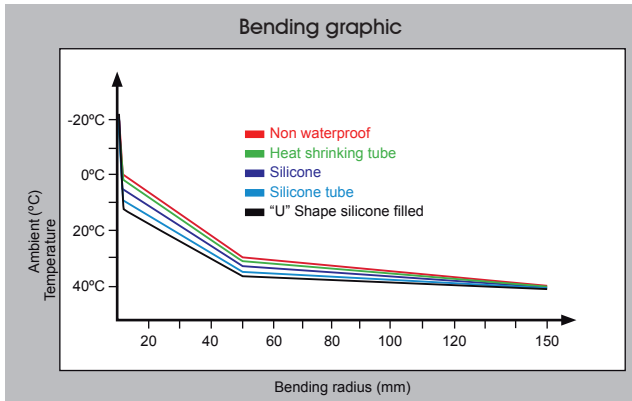

Reference point: strip bending at 0°C.

NON-WATERPROOF MODEL

Features

- IP20 easier assembling 3M VHB.
- Small in size, light in weight, flexible.



Optional accesories

ACC10-JOIN-600



ACC10-CABLE-600

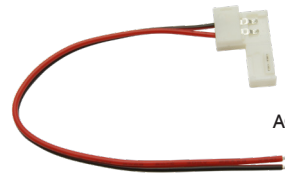

Operation specification

<p>Cut in specific location.</p>	<p>Put th PCB in the space between clip and connector, make the clips exactly aim at welding point.</p>	<p>Close the cover of connector</p>
----------------------------------	---	-------------------------------------

Product size

Front view

Units: mm

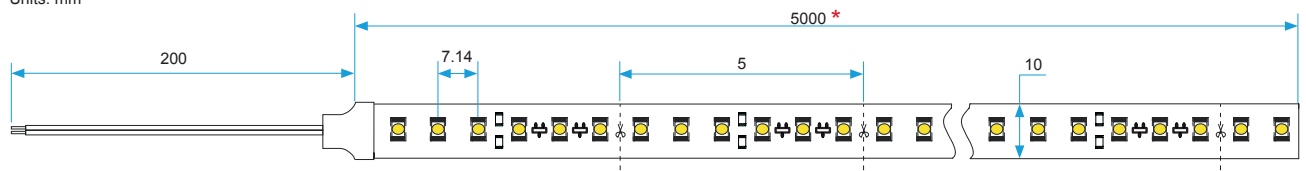

Size view

Units: mm

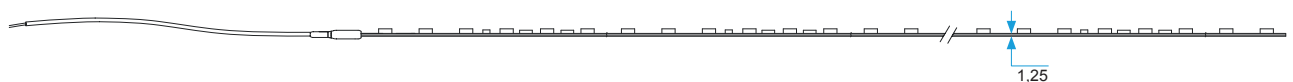

* 25 length models are available for references CCTX-2835F-XX-2X/25.
50 length models are available for references CCTX-2835F-XX-2X/50.

WATERPROOF MODEL

Features

- IP67 Rating with high performance molded silicone.
- High temperature, maximum flexibility, anti- UV, non toxic and improved optical transmittance >92%
- **New waterproof molded silicone system** to avoid CCT (color temperature) values modifications. Improved soldering pads in every cutting areas.



Optional accesories

Silicone caps



ACC10-CAPS-SIDE1

ACC10-CAPS-SIDE2

Male-female DC conectors



FU-BLF-CON-SEALED

Silicone gel tube



FU-BLF-GLUE

Handling

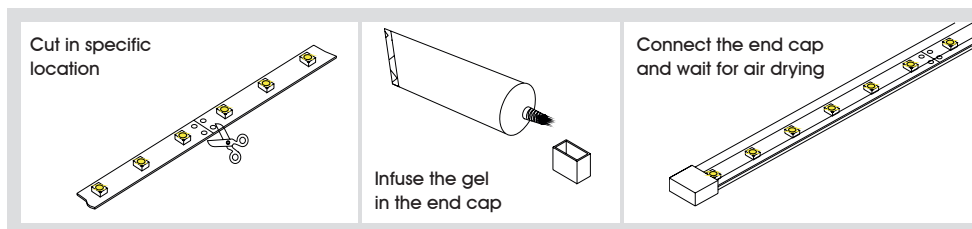

Product size

Front view

Units: mm

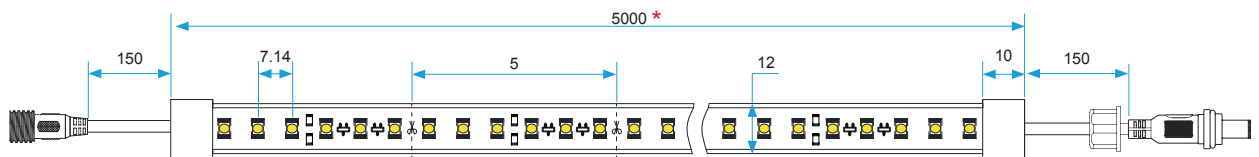

Side view

Units: mm

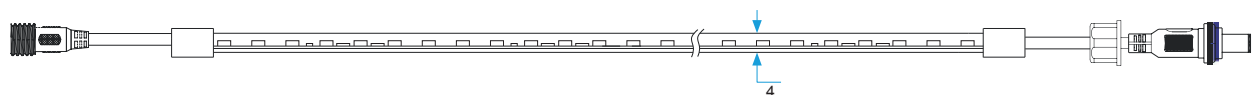

* 25 length models are available for references CCTX-2835F-XX-2WX/25.
50 length models are available for references CCTX-2835F-XX-2WX/50.

CONNECTION DIAGRAMS

Non dimmable option

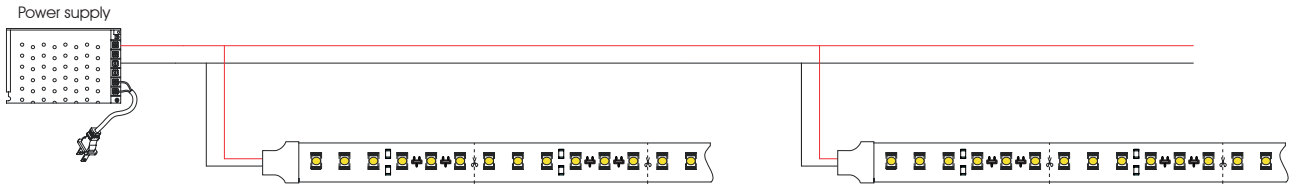

Dimmable option

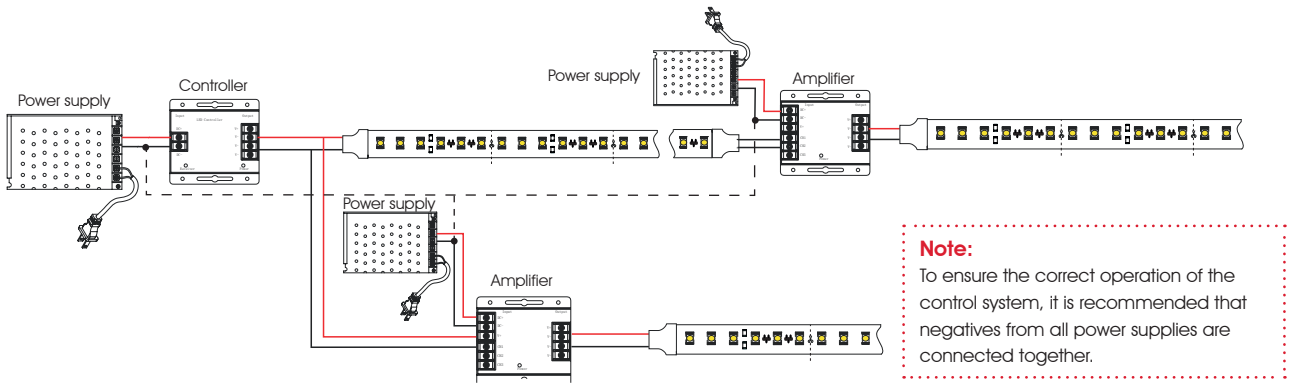

Note:
To ensure the correct operation of the control system, it is recommended that negatives from all power supplies are connected together.

INSTALLATION

Adhesive 3M VHB

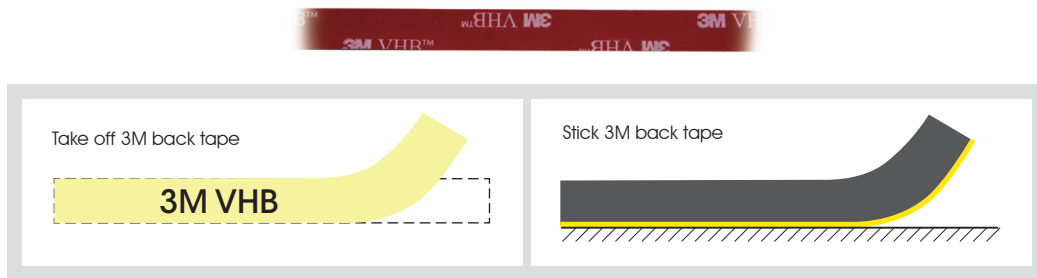

PACKAGING

