

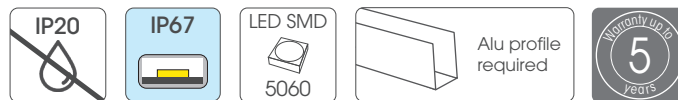

Smart Line professional Series

CVS-5060-BX-144*(W)

Programmable LED strip SMD5060 144 LED/m



Features

- Available in 144 pixel per meter.
- 3M VHB adhesive double side tape at the back.
- Built-in data signal reshaping circuit.
- 5VDC input supply voltage.
- Flexible construction material.
- Send data at speeds of 800Kbps.

Applications

- Bars, Disco rooms, Building decorations, Shopping malls, restaurants, hotels, meeting rooms.
- Advertisement signs.

* LM80 CERTIFIED:
LED LIFESPAN tested under LM80;
Expected LIFETIME of 30,000h.

CVS-5060-BX-144*(W)

Smart line professional series

Individual pixel. White

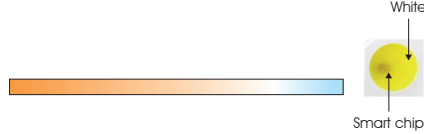

- 144**
Led/m
- 27**
W/m
- 5V**
- Warranty up to **5**
Years
- ≤2880**
lm/m
- LED SMD
5060
- standard
CRI >83
- smart chip
- SUPER BRIGHT
- Pixel 1 LED

Available PCB in black and white.

- CODIFICATION COLOR
WWW
- configuration
UCS1903
- Programmable
- VHB 3M
- driver NOT included
- 120°
- Alu profile required
- 30.000 h
- Parallel powered each 2,5 meters of LED strips
- Do not bend
- ESD
- 5m
- 7mm
- 7mm
- Working 50°C -20°C
- Storage 60°C -40°C

Features

Part number	CCT / wavelength	Luminous intensity per m / flux	Efficiency lm / W	Energy efficiency	Ordinary strip	Strip with waterproof part number "W" suffix
CVS-5060-BC-144B/N(W)	±3000K	± 2592lm	±96	F	 5000mm 1,25mm 12mm	Silicone tube 5000mm 4mm 14mm
CVS-5060-BN-144B/N(W)	±4000K	± 2736lm	±101	E		
CVS-5060-BF-144B/N(W)	±6000K	±2880lm	±106	E		

(B) —White PCB (N) —Black PCB

Notes



Customized packing is available for oem projects.

Specific parameters

Reference	Waterproof materials	Size (mm)	Connections	Fixing mode	IP rate
CVS-5060-BX-144	Non Waterproof	12x1.25	Silicone wire red and white	3 Wires with connector for data signal and 2 wires for power	IP20
CVS-5060-BX-144W	Silicone tube	14x4	Silicone wire red and white	3 Wires with connector for data signal and 2 wires for power	IP67

Bending grades

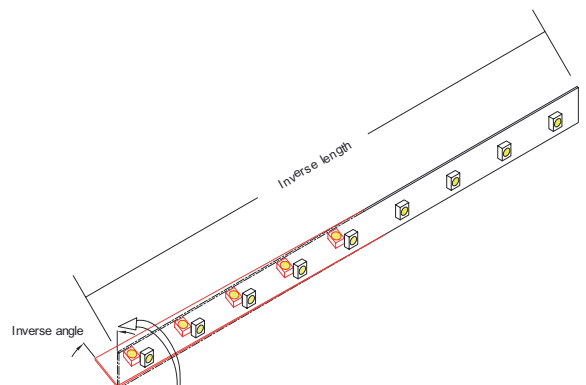
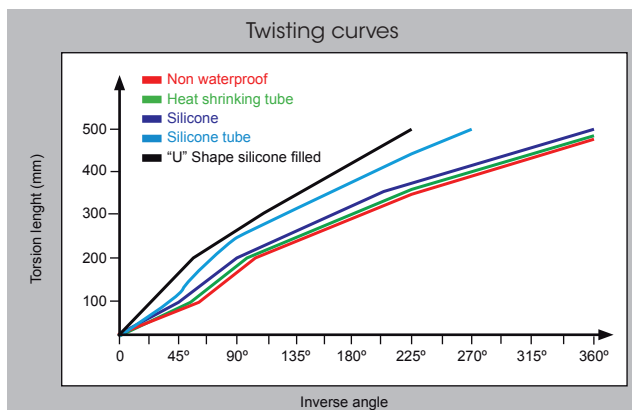
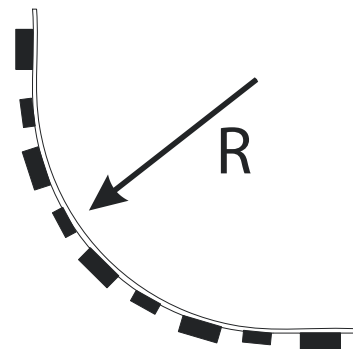
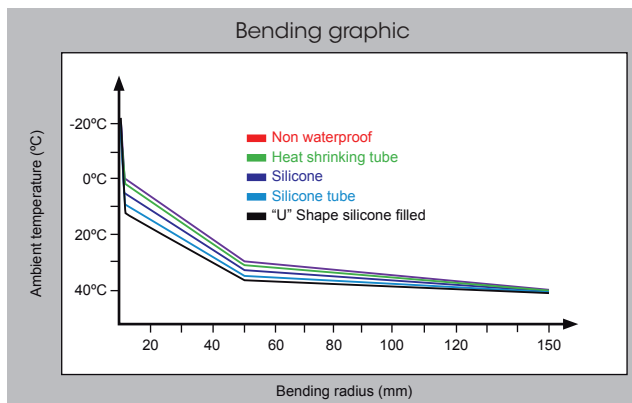

Reference point: strip bending at 0°C.

■ NON WATERPROOF MODEL

Features

- With 3M VHB adhesive tape, it is easy for installation. IP20.
- Small in size, light in weight, flexible.



Product size

Front view

Units: mm

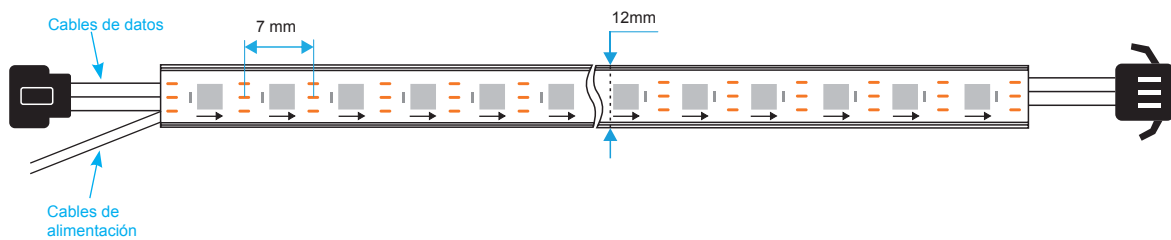

Side view

Units: mm

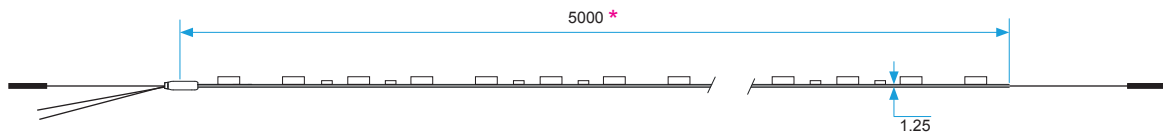

* Customized packing is available for oem projects.

■ **WATERPROOF MODEL**

Features

- The strip is well protected by silicone tube IP67.
- High temperature resistance high flexibility, anti UV, high light transmittance ($\geq 92\%$), non-toxic.

Operation specification

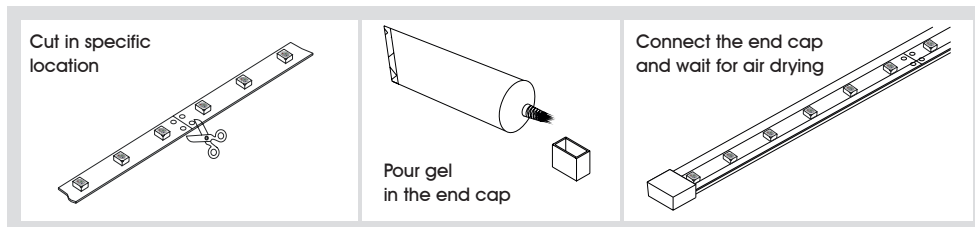

Product size

Front view

Units: mm

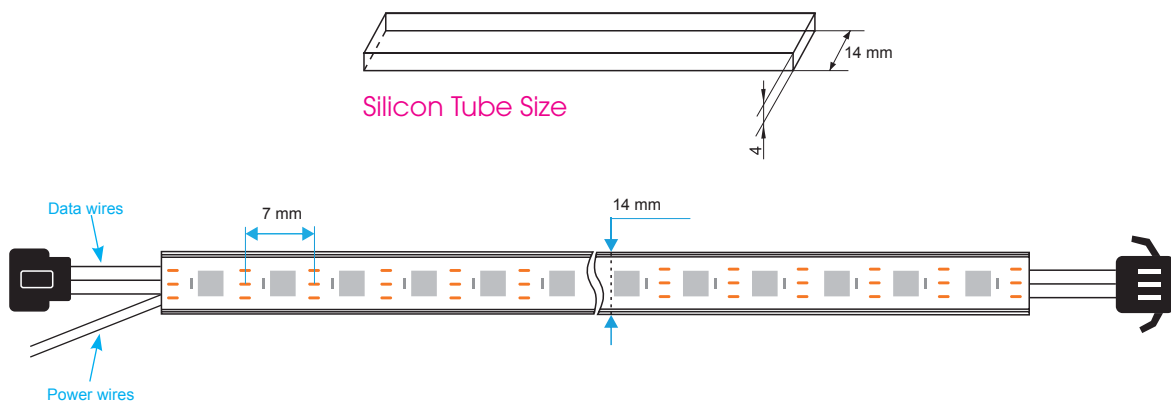

Side view

Units: mm

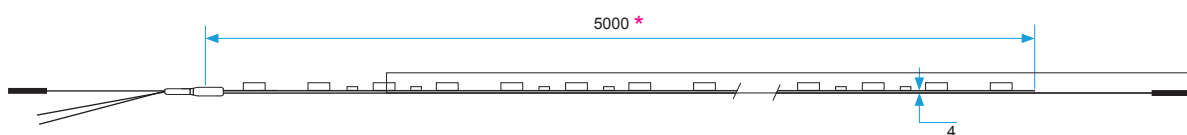

* Customized packing is available for oem projects.

CONNECTION DIAGRAMS

Non dimmable option

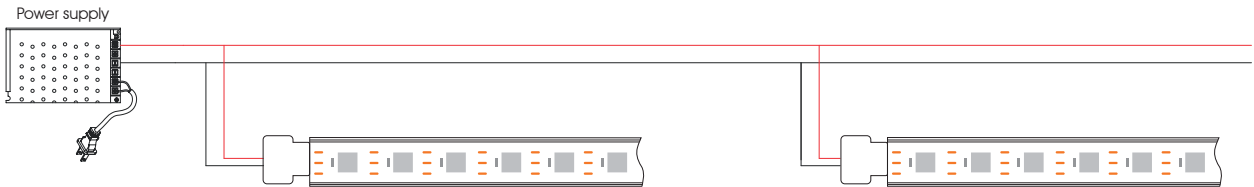

Dimmable option

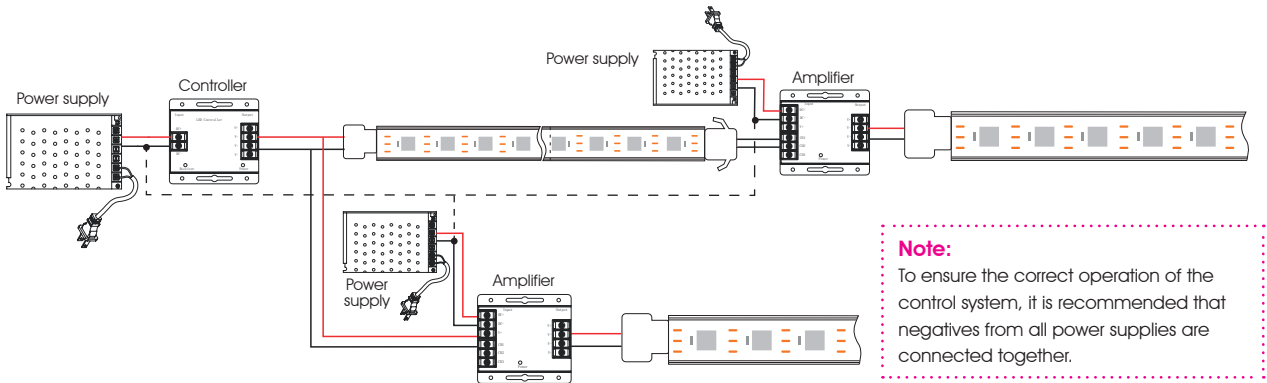

Adhesive 3M VHB



PACKAGING

