



Led Strip Professional Series

FU-BLF-2835-RGB-2X

Dimmable RGB strip with 120 SDM2835 leds per meter



Features

New PCB with ADF Technology, 50% thicker than previous one to improve cooling rate.

High Performance LM80 certified 2835 LEDs.

Cutting by groups to facilitate its use.

Uniform brightness throughout entire length.

24VDC power supply to get better reliability

Highest performance original 3M VHB back adhesive tape.

* LM80 CERTIFIED:
LED LIFESPAN tested under LM80;
Expected LIFETIME of 30,000h.

FU-BLF-2835-RGB-2X

Professional series

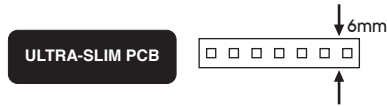

Dimmable strip 120 SMD2835 leds per meter

- 120 Led/m
- 17 W/m
- 24V
- Warranty up to 7 Years
- ≤780 lm/m
- LED SMD 2835
- FINE MIXING
- SUPER BRIGHT



RGB

RGB full color



- 5 Meters max. in series (one side powered)
- VHB 3M
- driver NOT included
- 120°
- 5m
- 8,33mm
- 5cm
- 30.000 h
- 10 Meters max. in series (two side powered)
- ADF PCB
- No doblar
- ESD
- Dimmable
- Alu profile required
- Working 50°C / -20°C
- Storage 60°C / -40°C

Features

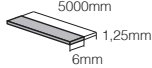
Part number	CCT / wavelength	Luminous intensity per m / flux	Efficiency lm / W	Energy efficiency	No waterproof strip
 FU-BLF-2835-RGB-2X	(R) 630nm (G) 525nm (B) 460nm	±780lm	±46	G	 

Notes

- 25m
- 50m

5/50 length models are available under request. Contact to our Sales Department.

Bending grades

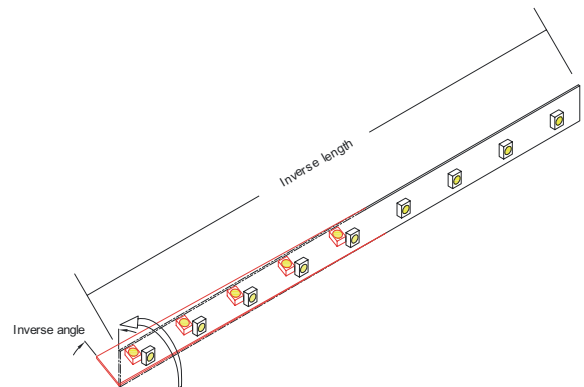
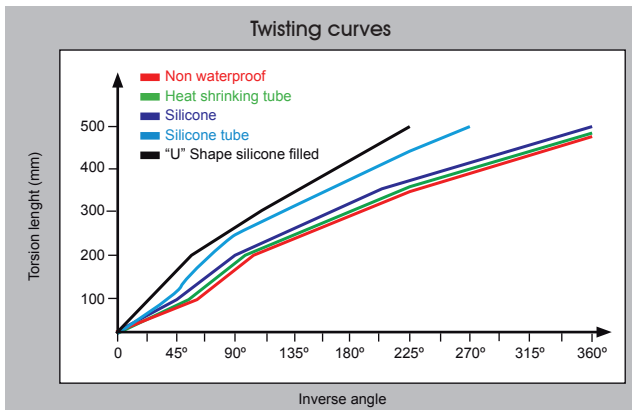
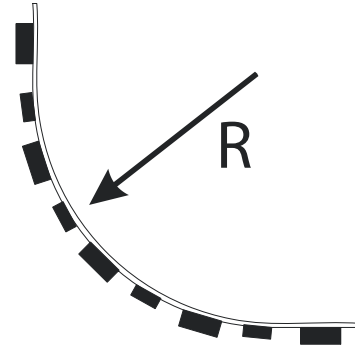
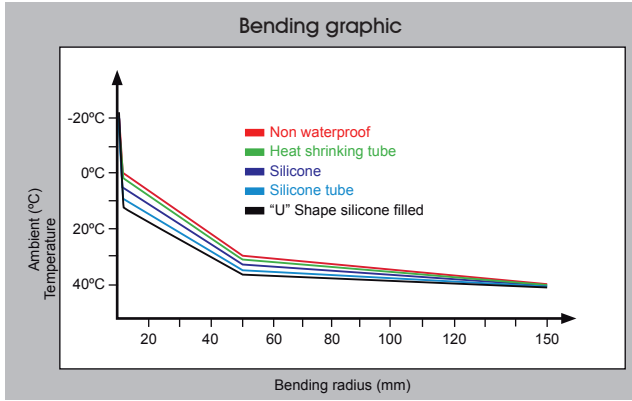

Reference point: strip bending at 0°C.

NON-WATERPROOF MODEL

Features

- IP20 easier assembling with 3M VHB adhesive tape.
- Small in size, light in weight, flexible.

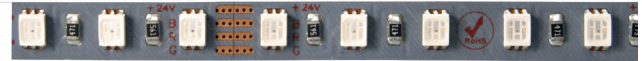

Operation specification

<p>Cut in specific location.</p>	<p>Put th PCB in the space between clip and connector, make the clips exactly aim at welding point.</p>	<p>Close the cover of connector</p>
----------------------------------	---	-------------------------------------

Product size

Front view

Units: mm

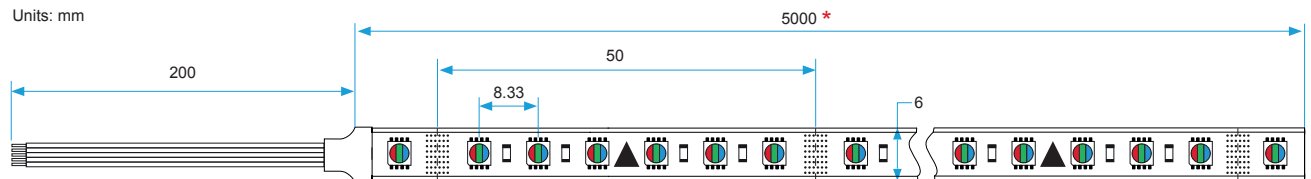

Side view

Units: mm

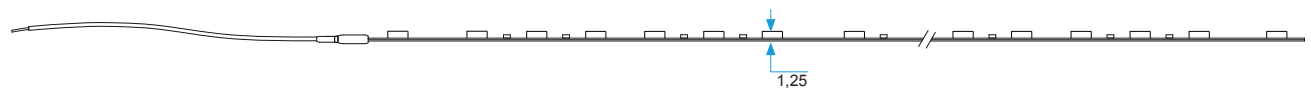

* 25 length models are available for references FU-BLF-2835-RGB-2X/25.
50 length models are available for references FU-BLF-2835-RGB-2X/50.

CONNECTION DIAGRAMS

Non dimmable option

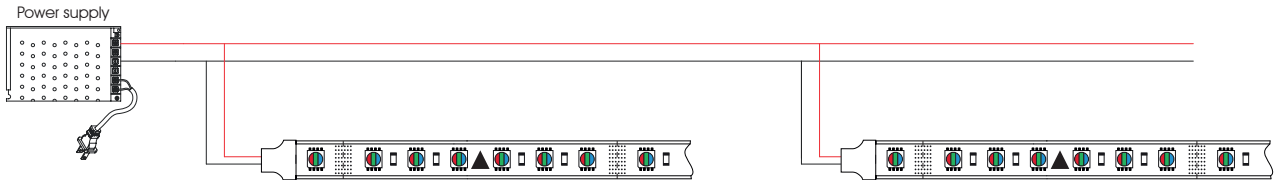

Dimmable option

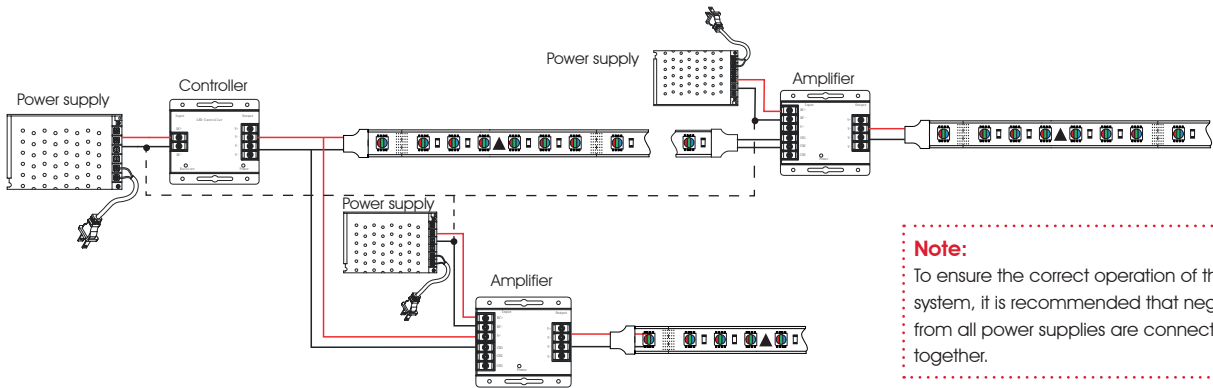

Note:
To ensure the correct operation of the control system, it is recommended that negatives from all power supplies are connected together.

INSTALLATION

Adhesive 3M VHB



PACKAGING

