

## 2CR5

### ■ Dimensions(mm)

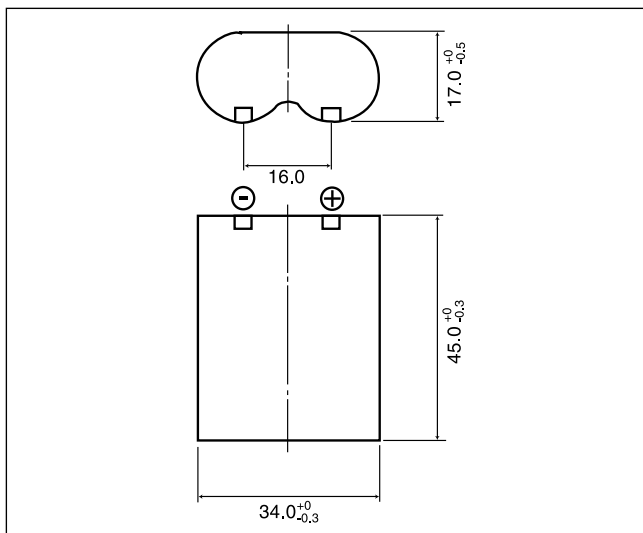

### ■ Specification

<b>Nominal voltage(V)</b>	6
<b>Nominal capacity(mAh)</b>	1,550
<b>Continuous drain(mA)</b>	20
<b>Operating temperature(°C)</b>	-40 to +70*

### ■ Discharge temperature characteristics

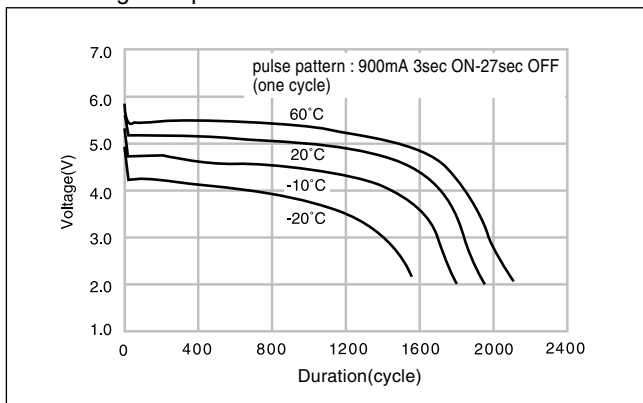

\* Please consult Panasonic for use below and above -20°C to +60°C.

## CR-P2

### ■ Dimensions(mm)

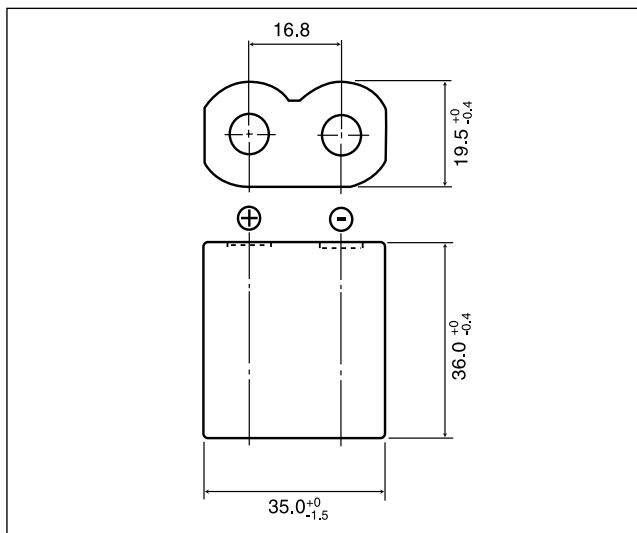

### ■ Specification

<b>Nominal voltage(V)</b>	6
<b>Nominal capacity(mAh)</b>	1,550
<b>Continuous drain(mA)</b>	20
<b>Operating temperature(°C)</b>	-40 to +70*

### ■ Discharge temperature characteristics

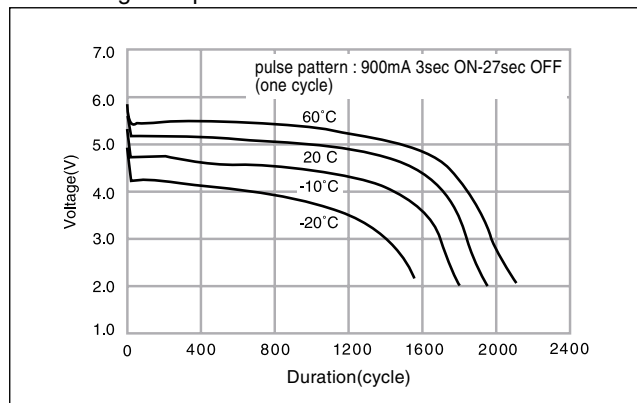

\* Please consult Panasonic for use below and above -20°C to +60°C.