



Led Strips Professional Series

FU-BLF-5060-BX-L160

Dimmable LED strip SMD5050 28 LED/m



Features

- View Angles 160 degree.
- With adhesive tape on backside.
- Made of high quality LEDs.
- Work Voltage: 12VDC.
- UL, CUL, CE, ROHS Approved.

Application

- Car decoration.
- Architectural decorative lighting.
- Archway, canopy and bridge edge lighting.
- Auditorium walkway lighting.
- Backlighting for signage letters.
- Channel letter lighting.

* LM80 CERTIFIED:
LED LIFESPAN tested under LM80;
Expected LIFETIME of 30.000h.

160 degree strip

FU-BLF-5060-BX-L160

Special series Back lighting



highest performance professional led strips

- 28**
Led/m
- 16,5**
W/m
- 12V**
- 7**
years
- ≤1600**
lm/m
- LED SMD
5050
- MacAdam
3 level
SDCM
BIN1
- standard
CRI
>80
- optional
CRI
>90

White color temperature range.

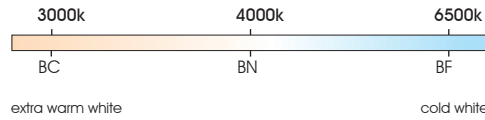

- 10 Max. meters in series (one side powered)
- VHB 3M
- driver NOT included
- 160°
- 5m
- 35,7mm
- 35,7mm
- 30.000 h
- 20 Max. meters in series (two side powered)
- ADF PCB
- Do not Bend
- ESD
- Dimmable
- Alu profile required
- Working 50°C -20°C
- Storage 60°C -40°C

Features

Part number	CCT / wavelength	Luminous intensity per m / flux	Efficiency lm / W	Energy efficiency	Ordinary strip
FU-BLF-5060-BC-L160	±3000~3500k	±1500lm	±91	F	 5000mm 3,2mm 10mm
FU-BLF-5060-BN-L160	±4000~4500k	±1550lm	±94	F	
FU-BLF-5060-BF-L160	±6000~6500k	±1600lm	±97	F	

Notes

Waterproof led strips covered by silicone material use to suffer an unavoidable CCT value modification owing to optical effect caused when light beam passes through material.
 Initial CCT values are increased several hundreds or thousands of °K. This increasing is much higher in coldest white CCTs.
 New FULLWAT molded silicone system avoids this effect and our waterproof led strips are CCT rated at original value without modification.
 Please, contact with your local sales office to get wider details.

- 25m
25 length models are available.
- 50m
50 length models are available under request.
Contact to our Sales Department.

Specific parameters

Reference	Waterproof materials	Size (mm)	Connections	Mode of fixation	IP rate
FU-BLF-5060-BF-L160	Non waterproof	10x3.2	Silicone wire red and white	Adhesive 3M VHB	IP20

Bending grades

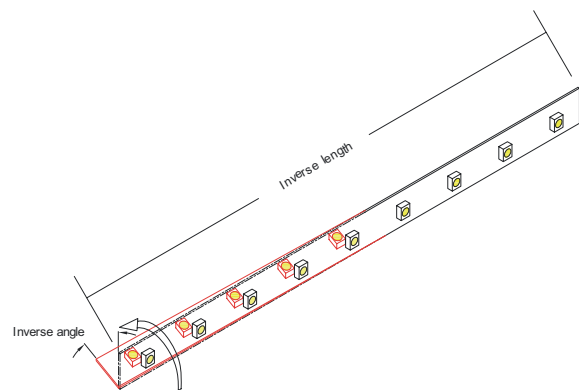
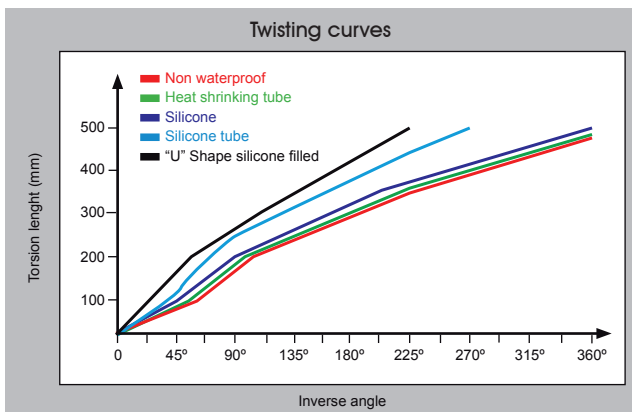
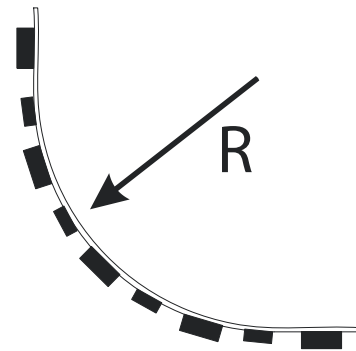
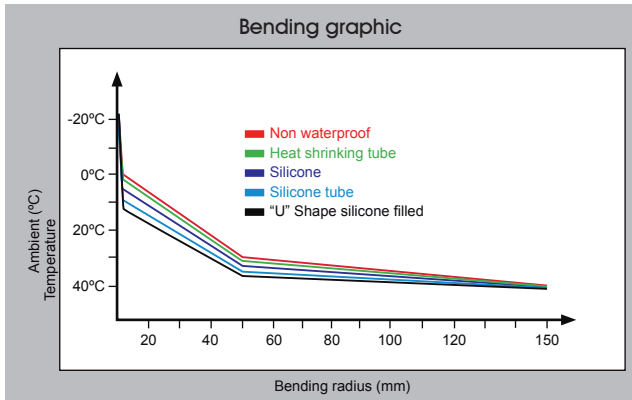

Reference point: strip bending at 0°C.

■ **NON WATERPROOF MODEL**

Features

- IP20 easier assembling 3M VHB.
- Small size, light weight, flexible.



Handling

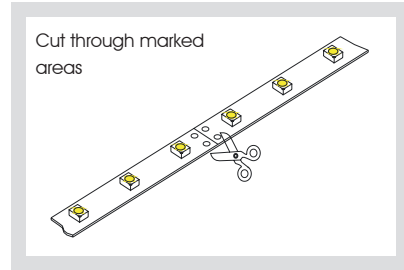

Product size

Frontal view

Units: mm

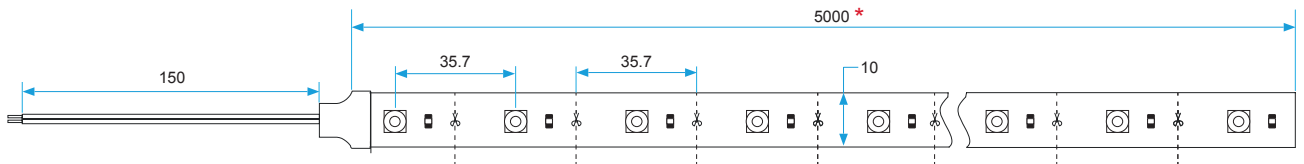

* 25 length models are available for references FU-BLF-5060-BX-L160/25.
50 length models are available for references FU-BLF-5060-BX-L160/50.

Side view

Units: mm

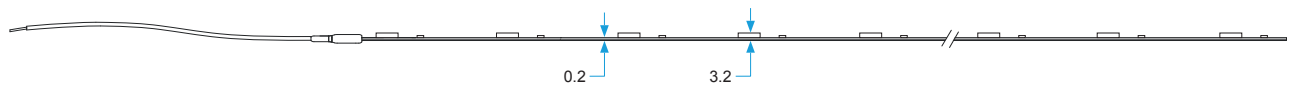

CONNECTION DIAGRAMS

Non dimmable option

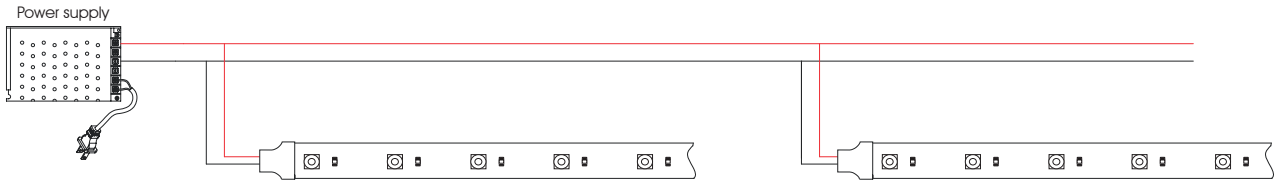

Dimmable option

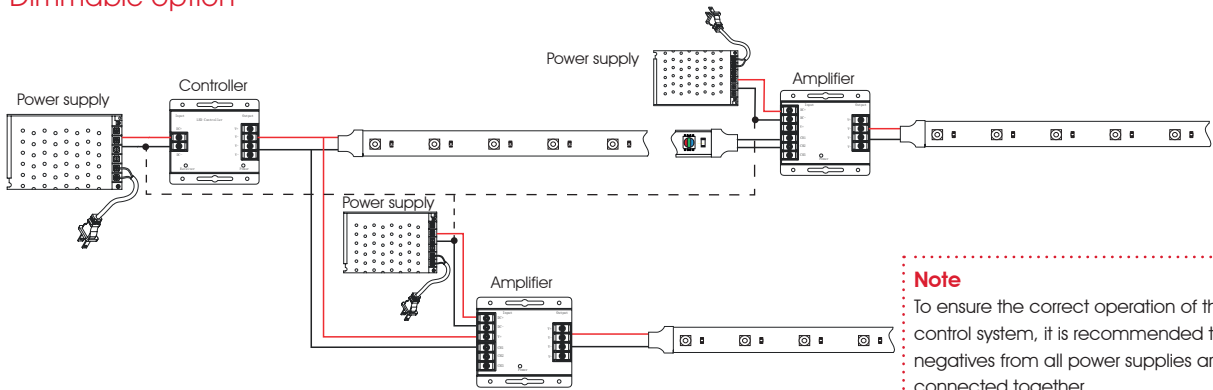

Note
To ensure the correct operation of the control system, it is recommended that negatives from all power supplies are connected together.

Adhesive 3M VHB

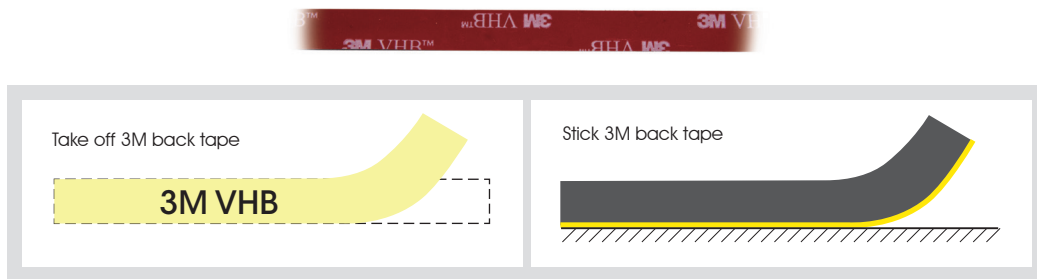

PACKAGING

