

## Food/meat products - Professional Series

MKT-2835-PKX-H2(W)X

Dimmable LED strip for meat products  
SMD2835 120led/m



### Features

**New PCB with ADF Technology**, 50% thicker than previous one to improve cooling rating.

Specials for presentation of meat products.

Constant current design that extends its useful life.

High Performance LM80 certified 2835 LEDs.

Cutting by groups to facilitate use.

Uniform brightness throughout entire length.

24VDC power supply to get better reliability

Highest performance original 3M VHB back adhesive tape.

International certificates available.

LED strips with special white color temperatures according to the phosphor diffusion treatment.

\* LM80 CERTIFIED:  
LED LIFESPAN tested under LM80;  
Expected LIFETIME of 30,000h.



MKT-2835-PKX-H2(W)X

Professional series

SMD2835 dimmable strip



- 120**  
Lcd/m
- 23**  
W/m
- 24V**
- 5**  
Years  
Warranty up to
- ≤2075**  
lm/m
- LED SMD  
2835
- MacAdam  
5 level  
SDCM  
BIN1
- CRI**  
modified
- SPECIAL HIGH BAY**
- pink

Color: pink level / meat type

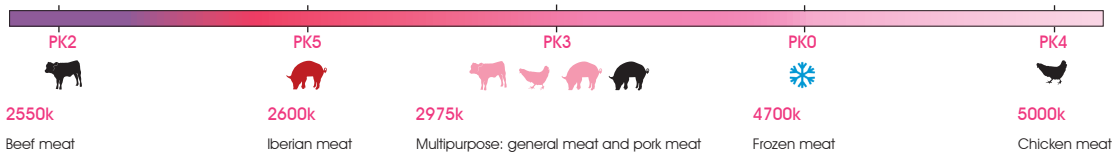

- 5 Max. meters in series (one side powered)
- VHB 3M
- driver NOT included
- 120°
- 5m
- 8.33mm
- 5cm
- 30.000 h
- 10 Max. meters in series (two side powered)
- ADF PCB
- Do not bend
- ESD
- Dimmable
- HIGH POWER Alu profile required
- Working 50°C -20°C
- Storage 60°C -40°C

Features

Part number	Luminous intensity per m / flux	Efficiency lm / W	Energy efficiency	Ordinary strip	Strip with waterproof part number "W" suffix	Meat type	MODIFIED CRI
MKT-2835-PK0-H2(W)X	±2075lm	±90	F	IP20	IP67	Frozen meat	82
MKT-2835-PK2-H2(W)X	±1460lm	±63	G	5000mm 10mm	5000mm 12mm	Beef meat	64
MKT-2835-PK3-H2(W)X	±1560lm	±68	G			Multipurpose: general meat and pork meat	81
MKT-2835-PK4-H2(W)X	±1845lm	±80	F			Chicken meat	76
MKT-2835-PK5-H2(W)X	±1845lm	±80	F			Iberian meat	72

Note

Waterproof versions are assembled with extrusioned mold system with no color temperature value changing.

Specific parameters

Reference	Waterproof materials	Size (mm)	Angles	Connections	Mode of fixation	IP grade	Working temperature
MKT-2835-PKX-H2X	Non waterproof	10x1,25	120°	Silicone wire Red and white	Adhesive 3M VHB	IP20	-10°C~40°C
MKT-2835-PKX-H2WX	extruded tube of sylicon	12x4,0	120°	5.5mm DC jack	Adhesive 3M VHB	IP67	-10°C~40°C

Curve Line

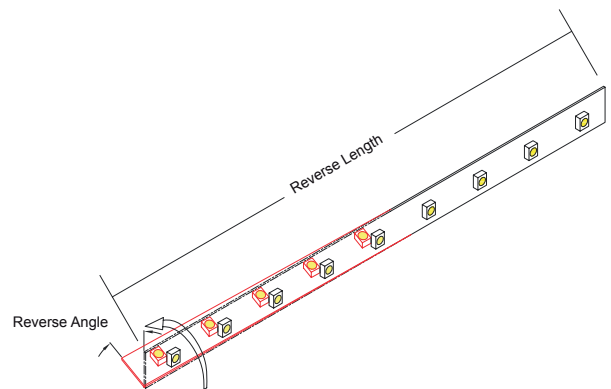
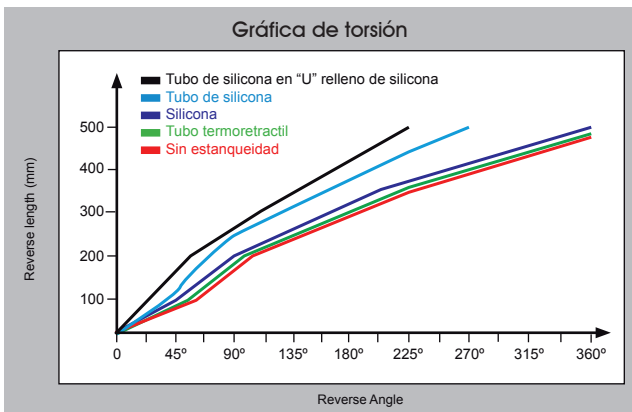
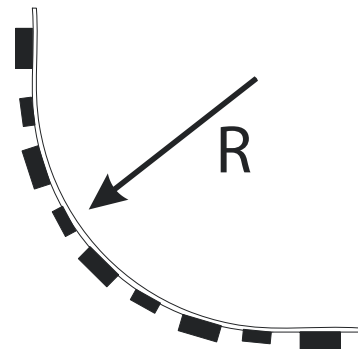
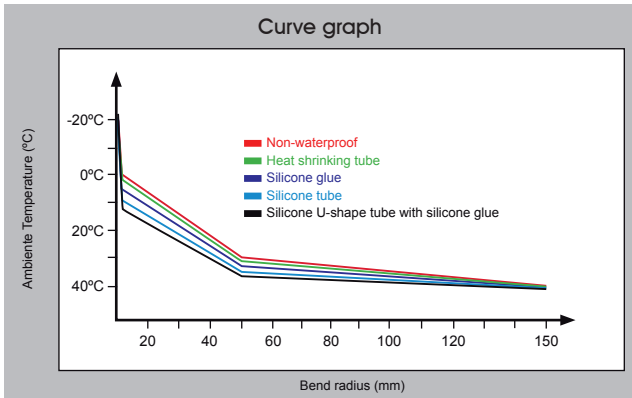

For reference, parameter in tje diagram is tested with 0°Celsius temperature.

**WATERPROOF MODEL**

**Features**

- The strip is protected by silicone tube IP67.
- High temperature resistance high flexibility, anti UV, high light transmittance ( $\geq 92\%$ ), non-toxic.
- New sealing system with extruded silicone that prevents changes to the original CCT value (color temperature). Easier handling of connections and welds between different sections.

**Optional accesories**

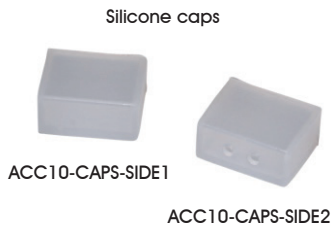

**Operation Specification**

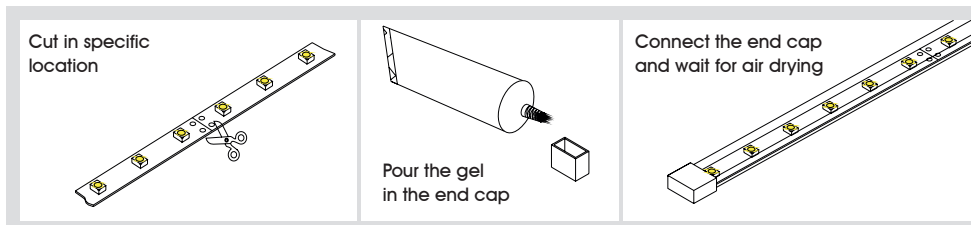

**Product size**

Front view

Units: mm

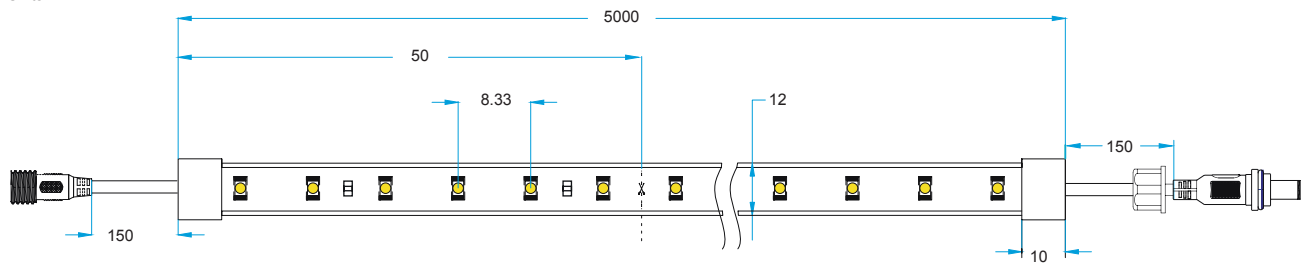

Side view

Units: mm

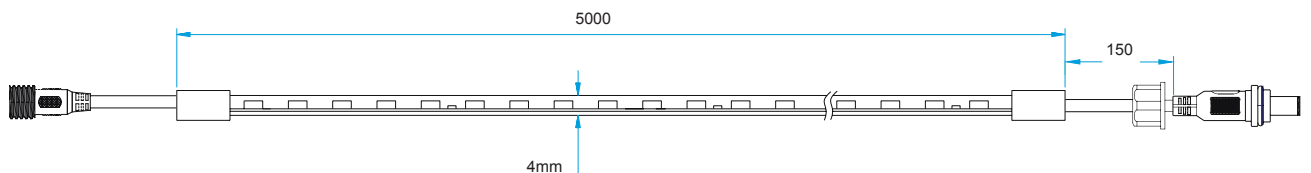

**NON WATERPROOF MODEL**

**Features**

- With 3M VHB adhesive tape, it is easy for installation, IP20.
- Small in size, light in weight, flexible..



**Optional accessories**

ACC10-JOIN-600



ACC10-CABLE-600

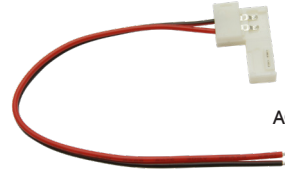

**Handing**

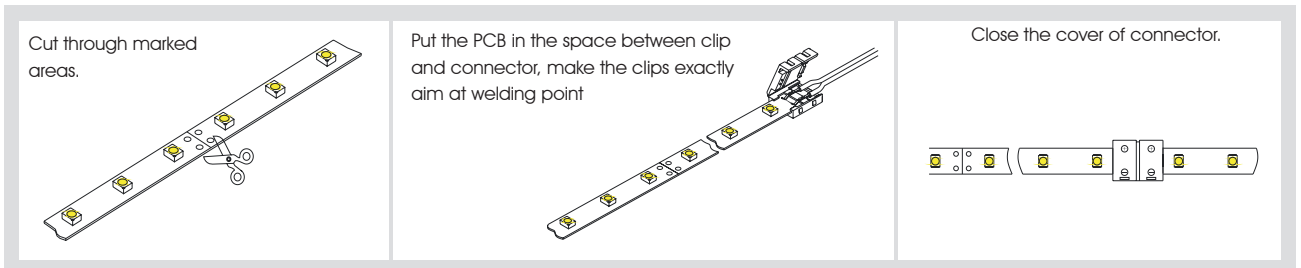

**Product size**

**Frontal view**

Units: mm

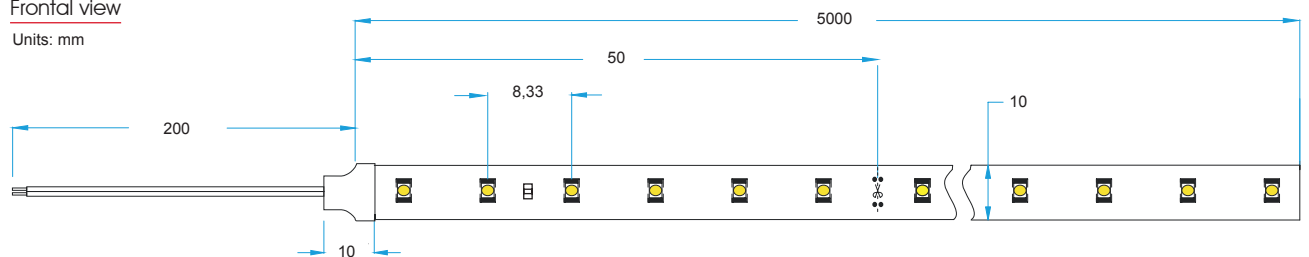

**Side view**

Units: mm

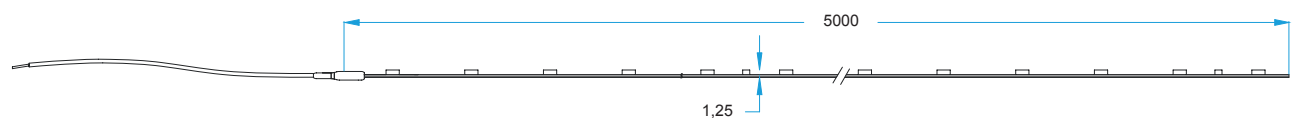

**CONNECTION DIAGRAMS**

Non dimmable option

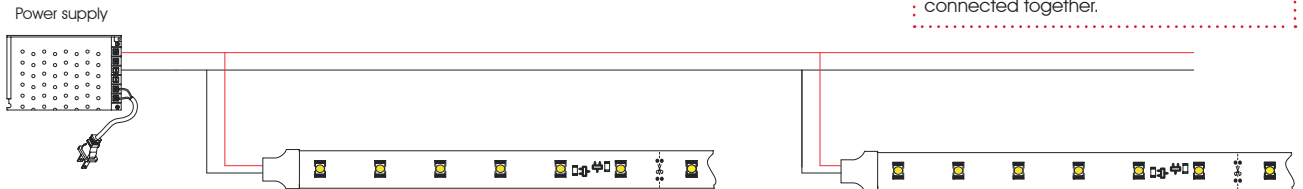

**Note:**  
To ensure the correct operation of the control system, it is recommended that negatives from all power supplies are connected together.

Dimmable option

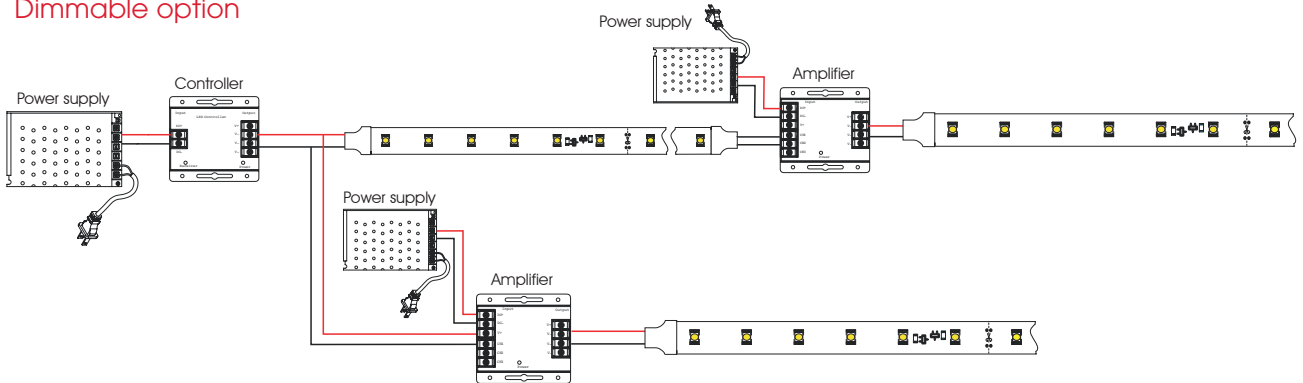

**INSTALLATION**

Adhesive 3M VHB

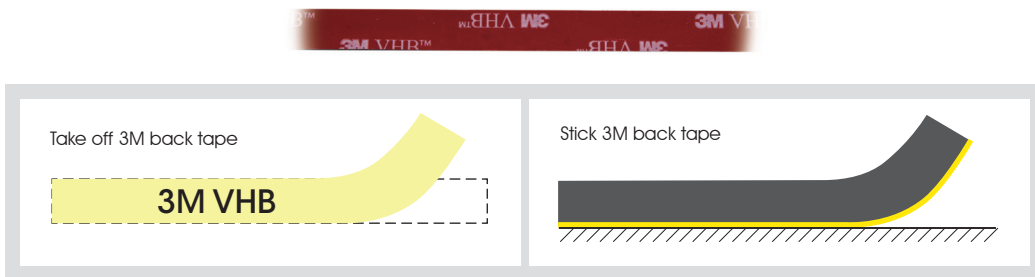

**PACKAGING**

