

UL 2.9 - 12

12V 2.9AH

STANDBY

Ultracell®

'Quality in Every Language'

Image



Terminal Type

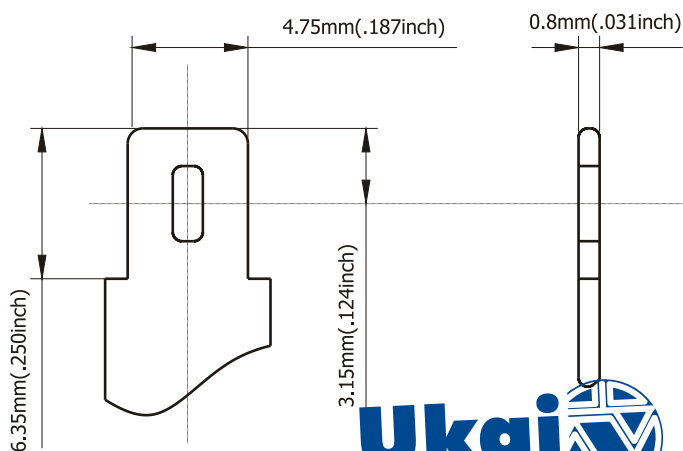

Ukai
s.a.
<http://www.ukai.com>

Ribera Elorrieta, 7C
48015 - Bilbao
Teléfono: 94 474 52 52
Fax: 94 475 97 10
E-mail: ukai@ukai.com

Dimensions

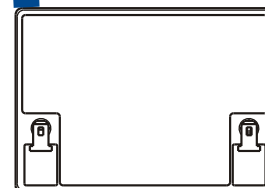
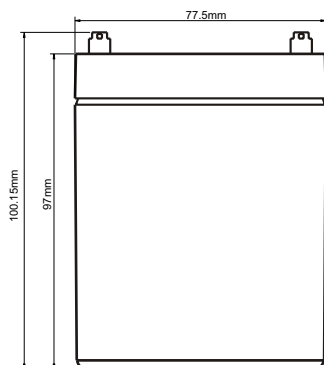

Specifications

Battery Model	UL 2.9 - 12			
Designed Floating Life	5 Years			
Capacity (25°C)	20HR (0.5A, 1.75V)	10HR (0.28A, 1.75V)	5HR (0.52A, 1.75V)	1HR (1.85A, 1.75V)
	3.0AH	2.8AH	2.5AH	1.85AH
Dimensions	Length	Width	Height	Total Height
	77.5mm	55mm	97mm	100.15mm
Approx. Weight	1.20Kg			
Internal Resistance	Fully Charged at 25°C 0.034 Ohm			
Self Discharge	3% of capacity declined per month at 25°C			
Capacity Affected by Temperature	40°C	25°C	0°C	-15°C
	102%	100%	85%	65%
Charge Voltage (25°C)	Cycle Use		Float Use	
	14.4 - 15V (-10mV/C), max. Current: 0.87A		13.6 - 13.8V (-20mV/C)	

Construction

Component ——— Raw material
Positive ——— Lead dioxide
Negative ——— Lead
Container ——— ABS (Flame Retardent optional)
Cover ——— ABS (Flame Retardent optional)

Sealed and maintenance free option

Sealant ——— Epoxy Resin
Safety Valve ——— EPDR
Terminal ——— Copper
Separator ——— Fibre Glass
Electrolyte ——— Sulphuric acid

Non-spillable construction design

Ukai
s.a.
<http://www.ukai.com>

UKAI BILBAO
Ribera Elorrieta 7C
48015 Bilbao
Teléfono: 94 474 5252
Fax: 94 475 9710
e-mail: ukai@ukai.com

UKAI BARCELONA
Avda. Vallcarca 74-76
08023 Barcelona
Teléfono: 93 284 0898
Fax: 93 210 6765
e-mail: ukaibcn@ukai.com

UKAI MADRID
Avda Andalucía 2, 2ª planta local 211
28700 San Sebastián de los Reyes
Teléfono: 91 659 0328
Fax: 91 659 0558
e-mail: ukaimad@ukai.com

UL 2.9 - 12

12V 2.9AH

STANDBY

Ultracell®

'Quality in Every Language'

Charge Characteristic

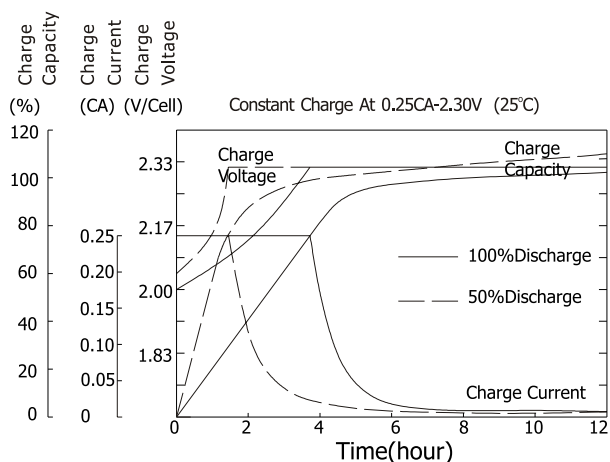

Discharge Characteristic 25°C

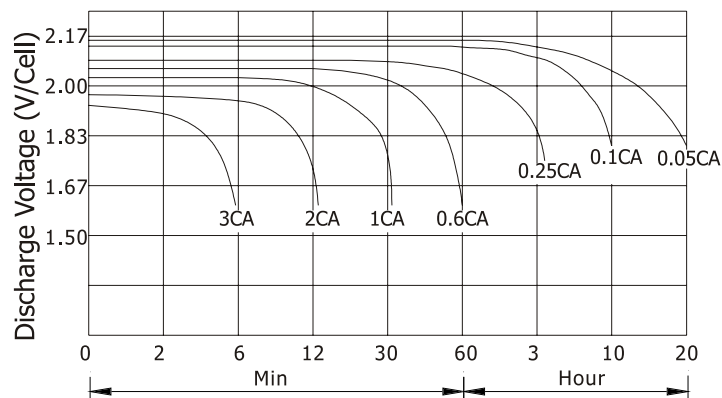

Relationship of OCV and state of charge

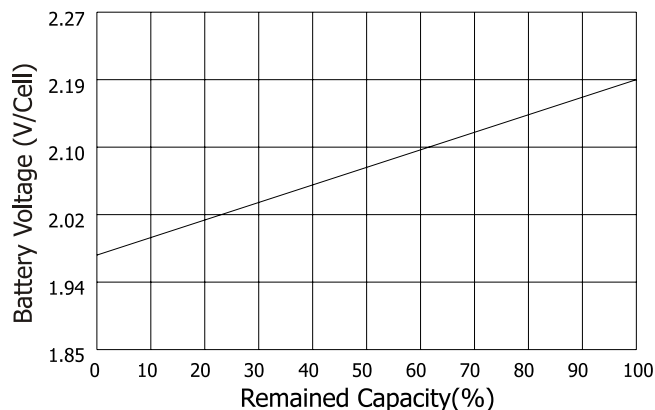

Self Discharge Characteristics

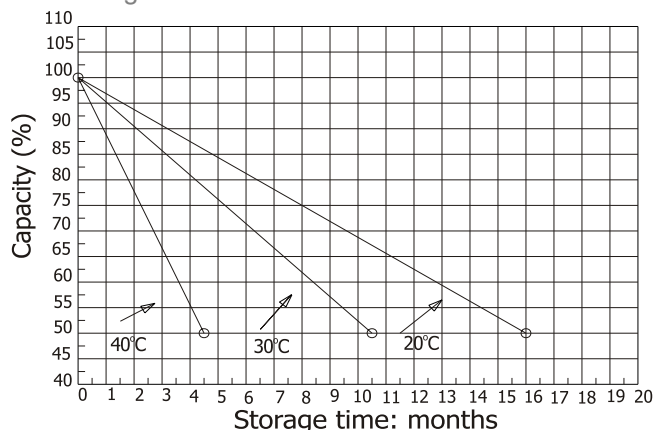

Constant Current Discharge Ratings - amperes at 25°C

F.V / Time	5 MIN	10 MIN	15 MIN	30 MIN	1 HR	3 HR	5 HR	10 HR	20 HR
1.60 V	11.1	6.93	5.23	3.19	2.03	0.89	0.54	0.29	0.16
1.67 V	10.5	6.57	5.03	3.05	2.00	0.86	0.53	0.29	0.15
1.70 V	9.58	6.33	4.91	2.77	1.94	0.80	0.52	0.29	0.15
1.75 V	9.39	6.14	4.75	2.63	1.85	0.77	0.51	0.29	0.15
1.80 V	8.40	5.86	4.31	2.44	1.73	0.74	0.48	0.28	0.14
1.85 V	7.41	5.58	3.88	2.24	1.61	0.71	0.45	0.28	0.14

Constant Power Discharge Ratings - watts at 25°C

F.V / Time	5 MIN	10 MIN	15 MIN	30 MIN	1 HR	3 HR	5 HR	10 HR	20 HR
1.60 V	19.5	12.5	9.54	5.74	3.66	1.58	0.92	0.61	0.32
1.67 V	18.8	12.2	9.42	5.62	3.63	1.53	0.91	0.60	0.31
1.70 V	17.7	12.1	9.34	5.26	3.56	1.46	0.90	0.60	0.30
1.75 V	17.9	12.0	9.26	5.11	3.50	1.43	0.89	0.59	0.30
1.80 V	16.3	11.9	8.59	4.87	3.30	1.38	0.87	0.59	0.29
1.85 V	14.8	11.2	7.79	4.56	3.10	1.34	0.84	0.58	0.28



UKAI BILBAO
 Ribera Elorrieta 7C
 48015 Bilbao
 Teléfono: 94 474 5252
 Fax: 94 475 9710
 e-mail: ukai@ukai.com

UKAI BARCELONA
 Avda. Vallcarca 74-76
 08023 Barcelona
 Teléfono: 93 284 0898
 Fax: 93 210 6765
 e-mail: ukaibcn@ukai.com

UKAI MADRID
 Avda Andalucía 2, 2ª planta local 211
 28700 San Sebastián de los Reyes
 Teléfono: 91 659 0328
 Fax: 91 659 0558
 e-mail: ukaimad@ukai.com