



深圳市拓普微科技开发有限公司

SHENZHEN TOPWAY TECHNOLOGY CO., LTD.

LMT028DHFWL-NBN

LCD Module User Manual

Prepared by: Chen Rili Date: 2018-03-15	Checked by: Date:	Approved by: Date:
--	----------------------------------	-----------------------------------

Rev.	Descriptions	Release Date
0.1	Preliminary New release	2018-03-15

Table of Content

1. Basic Specifications	3
1.1 Block Diagram	3
1.2 Terminal Functions	4
2. Absolute Maximum Ratings	5
3. Electrical Characteristics	5
3.1 DC Characteristics	5
3.2 AC Characteristics	6
3.3 Backlight control Timing	7
3.4 Reset Timing	7
4. Functions	8
4.1 Display Commands	8
4.2 Power off the LCD Module	13
4.3 Refreshing The LCD Module	13
5. Optical Characteristics	13
6. Design and Handling Precaution	15

1. Basic Specifications

Screen Size(Diagonal) :	2.8"
Color Depth:	65k colors
Number of dots :	320 x 240(RGB)
Active Area :	57.6x43.2 mm
Dot Pitch :	0.18x0.18 mm
Display Technology :	a-Si TFT active matrix
Display Mode :	Transmissive / Positive
Pixel Configuration :	RGB Stripe
Viewing Direction :	9H (*1) (gray scale inverse) 3H (*2)
Polarizer Surface Treatment:	Glare
Backlight Type:	LEDs
Outline Dimension :	79.3 x 49.1 x 6.8(Max) mm (see dwg for details)
Operating Temperature :	-20 ~ +70°C
Storage Temperature :	-30 ~ +80°C

Note:

- *1. For saturated color display content (eg. pure-red, pure-green, pure-blue, or pure-colors-combinations).
- *2. For "color scales" display content.
- *3. Color tone may slightly change by Temperature and Driving Condition.

1.1 Block Diagram

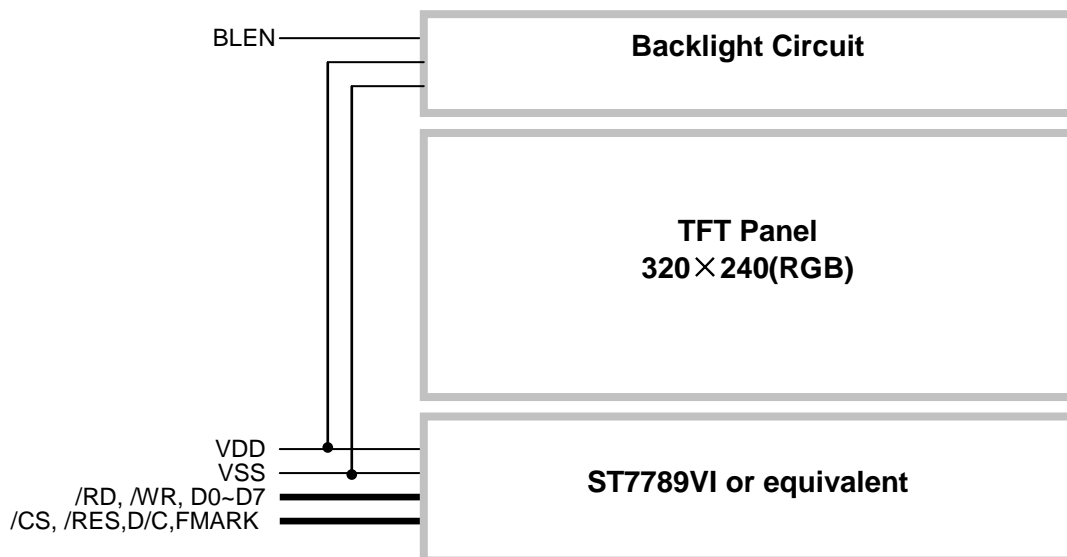

1.2 Terminal Functions

Pin No. (K3)	Pin Name	I/O	Descriptions
1	VSS	P	Negative power supply,0V
2	VSS		
3	BLEN	I	Backlight enable BLEN = H: turn on Backlight BLEN = L: turn off Backlight
4	VDD	P	Positive power supply
5	VDD		
6	/RD	I	Read enable input, active high
7	/WR	I	Write enable input, active low
8	D/C	I	Register Select D/C=H, Transferring the Display Data D/C = L, Transferring the Control Data
9	/CS	I	Chip Select /CS=L, enable access to the LCD module /CS=H, disable access to the LCD module
10	D0	I/O	Data Input
:	:	:	:
17	D7	I/O	Data Input
18	/RES	I	Reset signal /RES = L, Initialization is executed /RES = H, Normal running.
19	FMARK	O	Displaying Timing Frame Signal
20~28	NC	-	-

2. Absolute Maximum Ratings

VDD =5V, VSS=0V, T_{OP}=25°C

Items	Symbol	Min.	Max.	Unit	Condition
Supply Voltage	VDD	-0.3	+5.5	V	VSS= 0V
Input Voltage	V _{IN}	-0.3	+4.6	V	VSS = 0V
Operating Temperature	T _{OP}	-20	+70	°C	No Condensation
Storage Temperature	T _{ST}	-30	+80	°C	No Condensation

Cautions:

Any Stresses exceeding the Absolute Maximum Ratings may cause substantial damage to the device. Functional operation of this device at other conditions beyond those listed in the specification is not implied and prolonged exposure to extreme conditions may affect device reliability.

3. Electrical Characteristics

3.1 DC Characteristics

VDD=5V, VSS=0V, T_{OP}=25°C

Items	Symbol	MIN.	TYP.	MAX.	Unit	Condition / Application Pin
Operating Voltage	VDD	4.8	5.0	5.2	V	VDD
	IOVDD	1.65	3.0	3.6	V	IOVDD
Input High Voltage	V _{IH}	0.7* IOVDD	-	IOVDD	V	/RES,D0~D7,/CS
Input Low Voltage	V _{IL}	0	-	0.3* IOVDD	V	/RD,/WR,BLEN,D/C
Operating Current	I _{DD}	-	74.5	85	mA	Backlight are ON
	I _{DD}	-	6.25	16	mA	Backlight are OFF

3.2 AC Characteristics

8080 Mode System Bus Timing

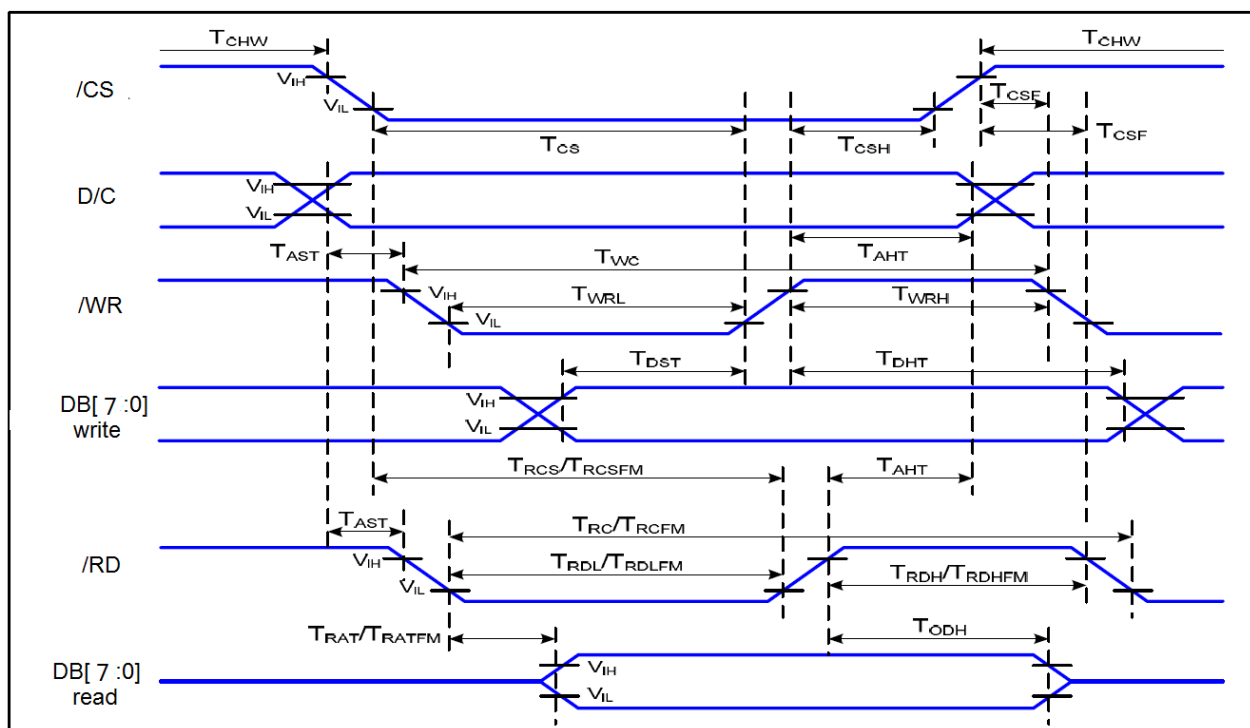
VDD = 5V, VSS = 0V, T_{OP} = 25°C

Signal	Symbol	Parameter	Spec.		Unit	Description
			Min.	Max.		
D/C	T _{AST}	Address setup time	5	-	ns	-
	T _{AHT}	Address hole time(Write/Read)	13	-		
/CS	T _{CHW}	Chip select "H" pulse width	5	-	ns	-
	T _{CS}	Chip select setup time(Write)	20	-		
	T _{RCS}	Chip select setup time(Read ID)	60	-		
	T _{RCSFM}	Chip select setup time(Read FM)	460	-		
	T _{CSF}	Chip select wait time(Write/Read)	13	-		
	T _{CSH}	Chip select hold time	13	-		
/WR	T _{WC}	Write cycle	86	-	ns	-
	T _{WRH}	Control pulse "H" duration	20	-		
	T _{WRL}	Control pulse "L" duration	20	-		
DB[7:0]	T _{DST}	Data setup time	13	-	ns	For maximum CL=30pF For minimum CL=8pF
	T _{DHT}	Data hold time	13	-		
	T _{RAT}	Read access time(ID)	-	52		
	T _{RATFM}	Read access time(FM)	-	442		
	T _{ODH}	Output disable time	14	104		
/RD(ID)	T _{RC}	Read cycle(ID)	208	-	ns	When read ID data
	T _{RDH}	Control pulse "H" duration(ID)	120	-		
	T _{RDL}	Control pulse "H" duration(ID)	60	-		
/RD(FM)	T _{RCFM}	Read cycle(FM)	585	-	ns	When read from frame memory
	T _{RDHFM}	Control pulse "H" duration(FM)	120	-		
	T _{RDLFM}	Control pulse "H" duration(FM)	460	-		

Note:

*1. Input signal rise/fall time should be less than 15ns .

*2. All timing is using 20% and 80% of VDD as the reference.

*3. Please refer to ST7789VI datasheet for details

3.3 Backlight control Timing

VDD=5V, VSS=0V, T_{OP} =25°C

Signal	Symbol	Parameter	Spec.			Unit	Description
			Min.	Typ	Max.		
BLEN	t _{HI}	Time Delay between Steps	2	-	-	us	H: 3.3V
	t _{LO}	CTRL LOW Time for Dimming	1	-	250	us	L: 0V
	t _{SD}	CTRL LOW ,shutdown Pulse Width	2	-	-	ms	

Note: For basic ON/OFF function, please beware of minimum pulse width.

Register BLEN timing

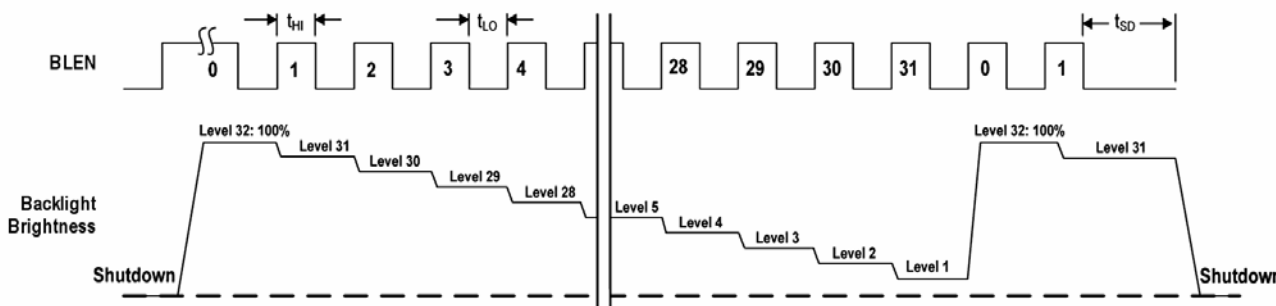

3.4 Reset Timing

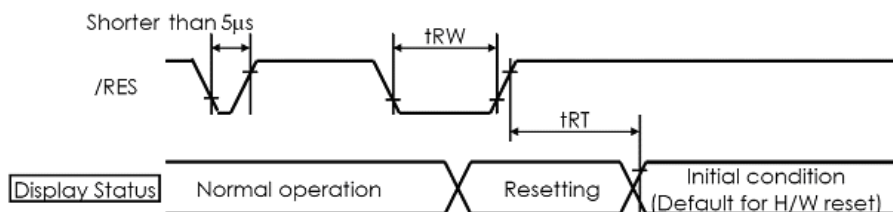

VDD =5V, VSS=0V, T_{OP}=25°C

Item	Symbol	MIN.	TYP.	MAX.	Unit
Reset LOW pulse width	t _{RW}	10	-	-	us
Reset time	T _{RT}	-	-	170	ms

4. Functions

4.1 Display Commands

Instruction	D/C	/WR	D17-8	D7	D6	D5	D4	D3	D2	D1	D0	Hex	Function
NOP	0	↑	-	0	0	0	0	0	0	0	0	(00h)	No operation
SWRESET	0	↑	-	0	0	0	0	0	0	0	1	(01h)	Software reset
RDDID	0	↑	-	0	0	0	0	0	1	0	0	(04h)	Read display ID
	1	1	-	-	-	-	-	-	-	-	-		Dummy read
	1	1	-	ID17	ID16	ID15	ID14	ID13	ID12	ID11	ID10		ID1 read
	1	1	-	ID27	ID26	ID25	ID24	ID23	ID22	ID21	ID20		ID2 read
	1	1	-	ID37	ID36	ID35	ID34	ID33	ID32	ID31	ID30		ID3 read
RDDST	0	↑	-	0	0	0	0	1	0	0	1	(09h)	Read display status
	1	1	-	-	-	-	-	-	-	-	-		Dummy read
	1	1	-	BSTON	MY	MX	MV	ML	RGB	MH	ST24		-
	1	1	-	ST23	IFPF2	IFPF1	IFPF0	IDMON	PTLON	SLOUT	NORON		-
	1	1	-	ST15	ST14	INVON	ST12	ST11	DISON	TEON	GCS2		-
1	1	-	GCS1	GCS0	TEM	ST4	ST3	ST2	ST1	ST0		-	
RDDPM	0	↑	-	0	0	0	0	1	0	1	0	(0Ah)	Read display power
	1	1	-	-	-	-	-	-	-	-	-		Dummy read
	1	1	-	BSTON	IDMON	PTLON	SLPOUT	NORON	DISON	0	0		
RDD MADCTL	0	↑	-	0	0	0	0	1	0	1	1	(0Bh)	Read display
	1	1	-	-	-	-	-	-	-	-	-		Dummy read
	1	1	-	MY	MX	MV	ML	RGB	MH	0	0		-
RDD COLMOD	0	↑	-	0	0	0	0	1	1	0	0	(0Ch)	Read display pixel
	1	1	-	-	-	-	-	-	-	-	-		Dummy read
	1	1	-	0	D6	D5	D4	0	D2	D1	D0		-
RDDIM	0	↑	-	0	0	0	0	1	1	0	1	(0Dh)	Read display image
	1	1	-	-	-	-	-	-	-	-	-		Dummy read
	1	1	-	VSSON	0	INVON	0	0	GC2	GC1	GC0		-
RDDSM	0	↑	-	0	0	0	0	1	1	1	0	(0Eh)	Read display signal
	1	1	-	-	-	-	-	-	-	-	-		Dummy read

Instruction	D/C	/WR	D17-8	D7	D6	D5	D4	D3	D2	D1	D0	Hex	Function
	1	1	-	TEON	TEM	0	0	0	0	0	0		-
RDDSDR	0	↑	-	0	0	0	0	1	1	1	1	(0Fh)	Read display self-diagnostic result
	1	1	-	-	-	-	-	-	-	-	-		Dummy read
	1	1	-	D7	D6	0	0	0	0	0	0		-
SLPIN	0	↑	-	0	0	0	1	0	0	0	0	(10h)	Sleep in
SLPOUT	0	↑	-	0	0	0	1	0	0	0	1	(11h)	Sleep out
PTLON	0	↑	-	0	0	0	1	0	0	1	0	(12h)	Partial mode on
NORON	0	↑	-	0	0	0	1	0	0	1	1	(13h)	Partial off (Normal)
INVOFF	0	↑	-	0	0	1	0	0	0	0	0	(20h)	Display inversion off
INVON	0	↑	-	0	0	1	0	0	0	0	1	(21h)	Display inversion on
GAMSET	0	↑	-	0	0	1	0	0	0	0	1	(26h)	Display inversion on
	1	↑	-	0	0	0	0	GC3	GC2	GC1	GC0		
DISPOFF	0	↑	-	0	0	1	0	1	0	0	0	(28h)	Display off
DISPON	0	↑	-	0	0	1	0	1	0	0	1	(29h)	Display on
CASET	0	↑	-	0	0	1	0	1	0	1	0	(2Ah)	Column address set
	1	↑	-	XS15	XS14	XS13	XS12	XS11	XS10	XS9	XS8		X address start:
	1	↑		XS7	XS6	XS5	XS4	XS3	XS2	XS1	XS0		$0 \leq XS \leq X$
	1	↑		XE15	XE14	XE13	XE12	XE11	XE10	XE9	XE8		X address start:
	1	↑		XE7	XE6	XE5	XE4	XE3	XE2	XE1	XE0		$S \leq XE \leq X$
RASET	0	↑	-	0	0	1	0	1	0	1	1	(2Bh)	Row address set
	1	↑	-	YS15	YS14	YS13	YS12	YS11	YS10	YS9	YS8		Y address start:
	1	↑		YS7	YS6	YS5	YS4	YS3	YS2	YS1	YS0		$0 \leq YS \leq Y$
	1	↑		YE15	YE14	YE13	YE12	YE11	YE10	YE9	YE8		Y address start:
	1	↑		YE7	YE6	YE5	YE4	YE3	YE2	YE1	YE0		$S \leq YE \leq Y$
RAMWR	0	↑	-	0	0	1	0	1	1	0	0	(2Ch)	Memory write
	1	↑	D1[17:8]	D1[7]	D1[6]	D1[5]	D1[4]	D1[3]	D1[2]	D1[1]	D1[0]		Write data
	1	↑	Dx[17:8]	Dx[7]	Dx[6]	Dx[5]	Dx[4]	Dx[3]	Dx[2]	Dx[1]	Dx[0]		
	1	↑	Dn[17:8]	Dn[7]	Dn[6]	Dn[5]	Dn[4]	Dn[3]	Dn[2]	Dn[1]	Dn[0]		
RAMRD	0	↑	-	0	0	1	0	1	1	1	0	(2Eh)	Memory read

Instruction	D/C	/WR	D17-8	D7	D6	D5	D4	D3	D2	D1	D0	Hex	Function
	1	1	-	-	-	-	-	-	-	-	-		Dummy read
	1	1	D1[17:8]	D1[7]	D1[6]	D1[5]	D1[4]	D1[3]	D1[2]	D1[1]	D1[0]		Read data
	1	1	Dx[17:8]	Dx[7]	Dx[6]	Dx[5]	Dx[4]	Dx[3]	Dx[2]	Dx[1]	Dx[0]		
	1	1	Dn[17:8]	Dn[7]	Dn[6]	Dn[5]	Dn[4]	Dn[3]	Dn[2]	Dn[1]	Dn[0]		
PTLAR	0	↑	-	0	0	1	1	0	0	0	0	(30h)	Partial start/end address set
	1	↑	-	PSL15	PSL14	PSL13	PSL12	PSL11	PSL10	PSL9	PSL8		Partial start address: (0, 1, 2, ..P)
	1	↑	-	PSL7	PSL6	PSL5	PSL4	PSL3	PSL2	PSL1	PSL0		
	1	↑	-	PEL15	PEL14	PEL13	PEL12	PEL11	PEL10	PEL9	PEL8		Partial end address (0, 1, 2, 3, , P)
VSCRDEF	0	↑	-	0	0	1	1	0	0	1	1	(33h)	Vertical scrolling definition
	1	↑	-	TFA15	TFA14	TFA13	TFA12	TFA11	TFA10	TFA9	TFA8		
	1	↑	-	TFA7	TFA6	TFA5	TFA4	TFA3	TFA2	TFA1	TFA0		
	1	↑	-	VSA15	VSA14	VSA13	VSA12	VSA11	VSA10	VSA9	VSA8		
	1	↑	-	VSA7	VSA6	VSA5	VSA4	VSA3	VSA2	VSA1	VSA0		
	1	↑	-	BFA15	BFA14	BFA13	BFA12	BFA11	BFA10	BFA9	BFA8		
	1	↑	-	BFA7	BFA6	BFA5	BFA4	BFA3	BFA2	BFA1	BFA0		
TEOFF	0	↑	-	0	0	1	1	0	1	0	0	(34h)	Tearing effect line off
TEON	0	↑	-	0	0	1	1	0	1	0	1	(35h)	Tearing effect line on
	1	↑	-	-	-	-	-	-	-	-	TEM		
MADCTL	0	↑	-	0	0	1	1	0	1	1	0	(36h)	Memory data access control
	1	↑	-	MY	MX	MV	ML	RGB	0	0	0		-
VSCRSADD	0	↑	-	0	0	1	1	0	1	1	1	(37h)	Vertical scrolling start address
	1	↑	-	VSP15	VSP14	VSP13	VSP12	VSP11	VSP10	VSP9	VSP8		
	1	↑	-	VSP7	VSP6	VSP5	VSP4	VSP3	VSP2	VSP1	VSP0		
IDMOFF	0	↑	-	0	0	1	1	1	0	0	0	(38h)	Idle mode off
IDMON	0	↑	-	0	0	1	1	1	0	0	1	(39h)	Idle mode on
COLMOD	0	↑	-	0	0	1	1	1	0	1	0	(3Ah)	Interface pixel format

Instruction	D/C	/WR	D17-8	D7	D6	D5	D4	D3	D2	D1	D0	Hex	Function
	1	↑	-	0	D6	D5	D4	0	D2	D1	D0		Interface format
RAMWRC	0	↑	-	0	0	1	1	1	1	0	0	(3Ch)	Memory write continue
	1	↑	D1[17:8]	D1[7]	D1[6]	D1[5]	D1[4]	D1[3]	D1[2]	D1[1]	D1[0]		Write data
	1	↑	Dx[17:8]	Dx[7]	Dx[6]	Dx[5]	Dx[4]	Dx[3]	Dx[2]	Dx[1]	Dx[0]		
	1	↑	Dn[17:8]	Dn[7]	Dn[6]	Dn[5]	Dn[4]	Dn[3]	Dn[2]	Dn[1]	Dn[0]		
RAMRDC	0	↑	-	0	0	1	1	1	1	1	0	(3Eh)	Memory read continue
	1	1	-	-	-	-	-	-	-	-	-		Dummy Read
	1	1	D1[17:8]	D1[7]	D1[6]	D1[5]	D1[4]	D1[3]	D1[2]	D1[1]	D1[0]		
	1	1	Dx[17:8]	Dx[7]	Dx[6]	Dx[5]	Dx[4]	Dx[3]	Dx[2]	Dx[1]	Dx[0]		
	1	1	Dn[17:8]	Dn[7]	Dn[6]	Dn[5]	Dn[4]	Dn[3]	Dn[2]	Dn[1]	Dn[0]		
TESCAN	0	↑	-	0	1	0	0	0	1	0	0	(44h)	Set tear scanline
	1	↑	-	N15	N14	N13	N12	N11	N10	N9	N8		
	1	↑	-	N7	N6	N5	N4	N3	N2	N1	N0		
RDTESCAN	0	↑	-	0	1	0	0	0	1	0	1	(45h)	Get scanline
	1	1	-	-	-	-	-	-	-	-	-		Dummy Read
	1	1	-	-	-	-	-	-	-	N9	N8		
	1	1	-	N7	N6	N5	N4	N3	N2	N1	N0		
WRDISBV	0	↑	-	0	1	0	1	0	0	0	1	(51h)	Write display brightness
	1	↑	-	DBV7	DBV6	DBV5	DBV4	DBV3	DBV2	DBV1	DBV0		
RDDISBV	0	↑	-	0	1	0	1	0	0	1	0	(52h)	Read display brightness value
	1	1	-	-	-	-	-	-	-	-	-		Dummy read
	1	1	-	DBV7	DBV6	DBV5	DBV4	DBV3	DBV2	DBV1	DBV0		
WRCTRLD	0	↑	-	0	1	0	1	0	0	1	1	(53h)	Write CTRL display
	1	↑	-	0	0	BCTRL	0	DD	BL	0	0		
RDCTRLD	0	↑	-	0	1	0	1	0	1	0	0	(54h)	Read CTRL value display
	1	1	-	-	-	-	-	-	-	-	-		Dummy read
	1	1	-	0	0	BCTRL	0	DD	BL	0	0		

Instruction	D/C	/WR	D17-8	D7	D6	D5	D4	D3	D2	D1	D0	Hex	Function
WRCACE	0	↑	-	0	1	0	1	0	1	0	1	(55h)	Write content adaptive brightness control and Color enhancemnet
	1	↑	-	CECTRL	0	CE1	CE0	0	0	C1	C0		
RDCABC	0	↑	-	0	1	0	1	0	1	1	0	(56h)	Read content adaptive brightness control
	1	1	-	-	-	-	-	-	-	-	-		Dummy read
	1	1	-	0	CECTRL	0	0	0	0	C1	C0		
WRCABCMB	0	↑	-	0	1	0	1	1	1	1	0	(5Eh)	Write CABC minimum brightness
	1	↑	-	CMB7	CMB6	CMB5	CMB4	CMB3	CMB2	CMB1	CMB0		
RDCABCMB	0	↑	-	0	1	0	1	1	1	1	1	(5Fh)	Read CABC minimum brightness
	1	1	-	-	-	-	-	-	-	-	-		Dummy read
	1	1	-	CMB7	CMB6	CMB5	CMB4	CMB3	CMB2	CMB1	CMB0		
RDID1	0	↑	-	1	1	0	1	1	0	1	0	(Dah)	Read ID1
	1	1	-	-	-	-	-	-	-	-	-		Dummy read
	1	1	-	ID17	ID16	ID15	ID14	ID13	ID12	ID11	ID10		Read parameter
RDID2	0	↑	-	1	1	0	1	1	0	1	1	(DBh)	Read ID2
	1	1	-	-	-	-	-	-	-	-	-		Dummy read
	1	1	-	ID27	ID26	ID25	ID24	ID23	ID22	ID21	ID20		Read parameter
RDID3	0	↑	-	1	1	0	1	1	1	0	0	(DCh)	Read ID3
	1	1	-	-	-	-	-	-	-	-	-		Dummy read
	1	1	-	ID37	ID36	ID35	ID34	ID33	ID32	ID31	ID30		Read parameter

Notes:

- There will be no abnormal visible effects on the display when S/W or H/W Reset are applied.
- Please refer to ST7789s datasheet for details

4.2 Power off the LCD Module

It recommends that enter Sleep Mode before power off the LCD module.

4.3 Refreshing The LCD Module

It recommends that the operating modes and display contents be refreshed periodically to prevent the effect of unexpected noise.

5. Optical Characteristics

Item	Symbol	Condition	MIN.	TYP.	MAX.	UNIT	Note.
Viewing angle	$\Phi=90^\circ$	$(CR \geq 10)$	50	60	-	degree	Note 1,6
	$\Phi=270^\circ$		50	60	-		
	$\Phi=180^\circ$		40	50	-		
	$\Phi=0^\circ$		50	60	-		
Contrast ratio	CR	$\Phi=0^\circ$ $\theta=0^\circ$	300	500	-	-	Note 3
Response Time	T_{on}	$\Phi=0^\circ$ $\theta=0^\circ$	-	30	50	msec	Note 4
	T_{off}					msec	
Chromaticity	Red	Backlight is on $\Phi=0^\circ$ $\theta=0^\circ$	X	0.55	0.60	0.65	Note 1,5
			Y	0.30	0.35	0.40	
	Green		X	0.27	0.32	0.37	
			Y	0.56	0.61	0.66	
	Blue		X	0.09	0.14	0.19	
			Y	0.05	0.09	0.15	
	White		X	0.26	0.29	0.32	
			Y	0.28	0.31	0.34	
NTSC Ratio	S		45	65	-	%	
Luminance	L	$\Phi=0^\circ$	200	250	-	cd/m^2	Note 1,6
Luminance uniformity	U	$\theta=0^\circ$	80	-	-	%	Note 1,6

Note 1:
 The data are measured after LEDs are turned on for 5 minutes. LCM displays full white. The brightness is the average value of 9 measured spots. Measurement equipment PR-705
Measuring condition:
 - Measuring surroundings: Dark room
 - Measuring temperature: Ta=25°C.
 - Adjust operating voltage to get optimum contrast at the center of the display.

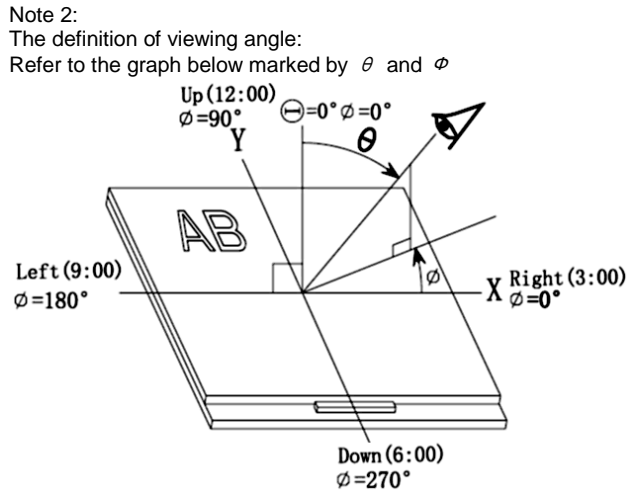

Note 3:
 The definition of contrast ratio (Test LCM using PR-705):

$$\text{Contrast Ratio (CR)} = \frac{\text{Luminance When LCD is at "White" state}}{\text{Luminance When LCD is at "Black" state}}$$
 (Contrast Ratio is measured in optimum common electrode voltage)

Note 4:
 Definition of Response time. (Test LCD using DMS501):
 The output signals of photo detector are measured when the input signals are changed from "black" to "white" (falling time) and from "white" to "black" (rising time), respectively. The response time is defined as the time interval between the 10% and 90% of amplitudes. Refer to figure as below.

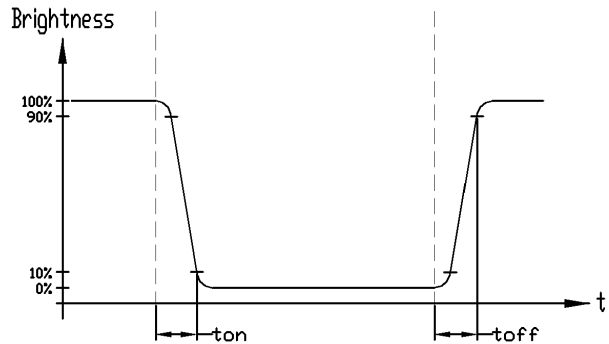

Note 5:
 Definition of Color of CIE1931 Coordinate and NTSC Ratio.

Color gamut:

$$S = \frac{\text{Area of RGB triangle}}{\text{Area of NTSC triangle}} \times 100\%$$

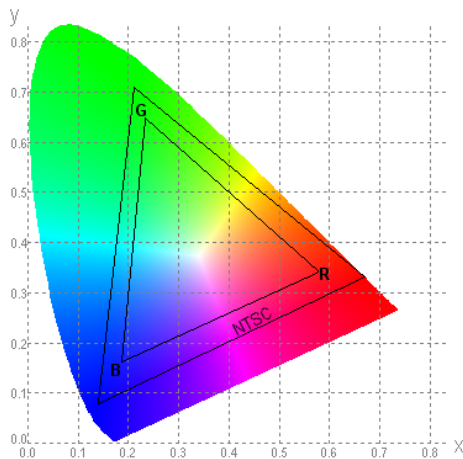

Note 6:
 The luminance uniformity is calculated by using following formula.

$$\Delta Bp = Bp (\text{Min.}) / Bp (\text{Max.}) \times 100 (\%)$$

 Bp (Max.) = Maximum brightness in 9 measured spots
 Bp (Min.) = Minimum brightness in 9 measured spots.

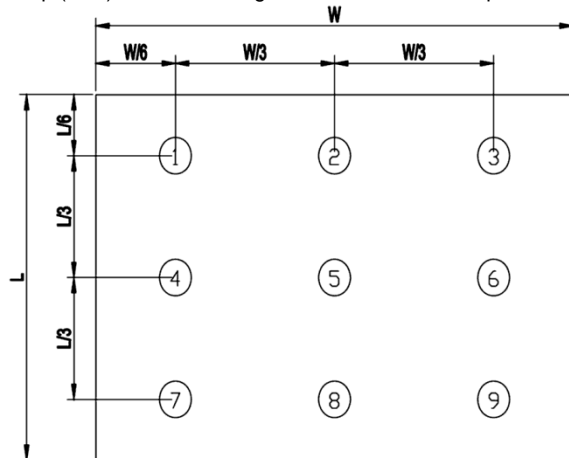

Note 7:
 Measured the luminance of white state at center point

6. Design and Handling Precaution

1. The LCD panel is made by glass. Any mechanical shock (eg. dropping from high place) will damage the LCD module.
2. Do not add excessive force on the surface of the display, which may cause the Display color change abnormally.
3. The polarizer on the LCD is easily get scratched. If possible, do not remove the LCD protective film until the last step of installation.
4. Never attempt to disassemble or rework the LCD module.
5. Only Clean the LCD with Isopropyl Alcohol or Ethyl Alcohol. Other solvents (eg. water) may damage the LCD.
6. When mounting the LCD module, make sure that it is free from twisting, warping and distortion.
7. Ensure to provide enough space (with cushion) between case and LCD panel to prevent external force adding on it, or it may cause damage to the LCD or degrade the display result.
8. Only hold the LCD module by its side. Never hold LCD module by add force on the heat seal or TAB.
9. Never add force to component of the LCD module. It may cause invisible damage or degrade of the reliability.
10. LCD module could be easily damaged by static electricity. Be careful to maintain an optimum anti-static work environment to protect the LCD module.
11. When peeling off the protective film from LCD, static charge may cause abnormal display pattern. It is normal and will resume to normal in a short while.
12. Take care and prevent get hurt by the LCD panel sharp edge.
13. Never operate the LCD module exceed the absolute maximum ratings.
14. Keep the signal line as short as possible to prevent noisy signal applying to LCD module.
15. Never apply signal to the LCD module without power supply.
16. IC chip (eg. TAB or COG) is sensitive to the light. Strong lighting environment could possibly cause malfunction. Light sealing structure casing is recommend.
17. LCD module reliability may be reduced by temperature shock.
18. When storing the LCD module, avoid exposure to the direct sunlight, high humidity, high temperature or low temperature. They may damage or degrade the LCD module