

# fullwat<sup>®</sup>

professional *solutions*

PDA1500-STATION / PDA3000-STATION series



pure sine wave

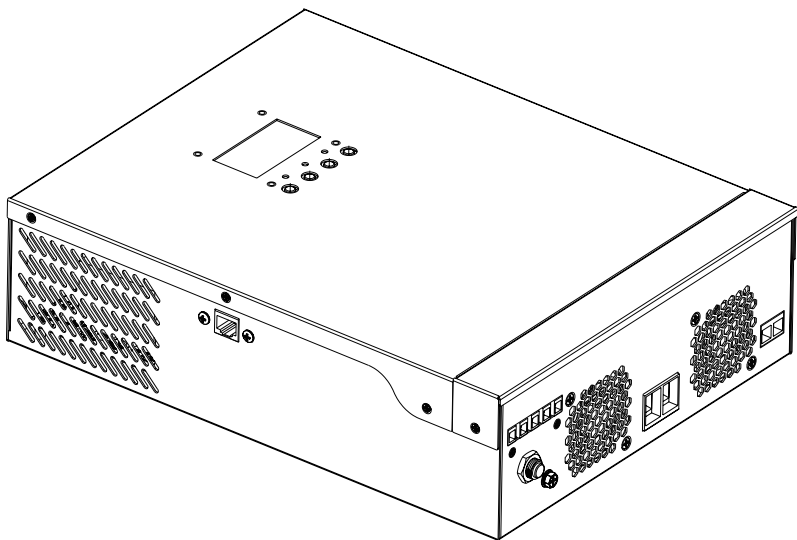

**Power DC-AC Inverter**

**Multi-function INVERTER/CHARGER:**

**inverter + MPPT solar charger + battery charger**



# 1. INTRODUCTION

This is a multi-function inverter/charger, combining functions of inverter, solar charger and battery charger to offer uninterrupted power support with portable size. Its comprehensive LCD display offers user-configurable and easy-accessible button operation such as battery charging current, AC/solar charger priority, and acceptable input voltage based on different applications.

# 2. FEATURES

- Pure sine wave inverter.
- Configurable input voltage range for home appliances and personal computers via LCD setting Configurable battery charging current based on applications via LCD setting.
- Configurable AC/Solar Charger priority via LCD setting.
- Compatible to mains voltage or generator power.
- Auto restart while AC is recovering.
- Overload/ Over temperature/ short circuit protection.
- Smart battery charger design for optimized battery performance.
- Cold start function.
- MPPT mode regulation charger.

# 3. BASIC SYSTEM ARCHITECTURE

The following illustration shows basic application for this inverter/charger. It also includes following devices to have a complete running system:

- Generator or Utility.
- PV modules (option).

Consult with your system integrator for other possible system architectures depending on your requirements.

This inverter can power all kinds of appliances in home or office environment, including motor-type appliances such as tube light, fan, refrigerator and air conditioner.

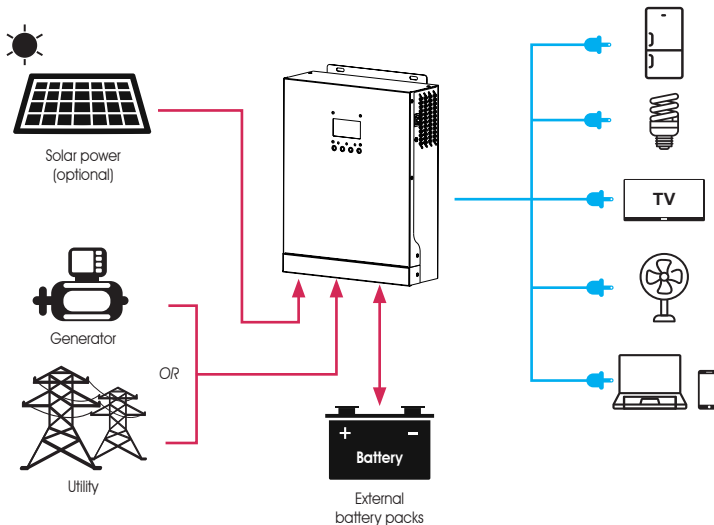
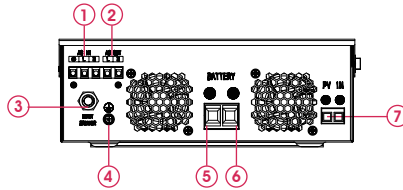
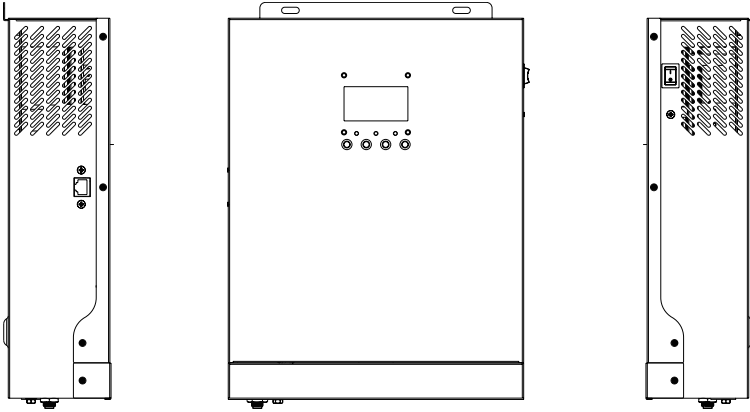

Fig. 1 - Hybrid power system

## 4. PRODUCT OVERVIEW



### Indication

- |                   |                         |                       |
|-------------------|-------------------------|-----------------------|
| ① AC Input        | ④ Safety (Earth) ground | ⑦ PV Input            |
| ② AC Output       | ⑤ Battery positive      | ⑧ ON / OFF            |
| ③ Circuit breaker | ⑥ Battery negative      | ⑨ RS232 communication |

## 5. INSTALLATION

### 5.1 Unpacking and Inspection

Before installation, please inspect the unit. Be sure that nothing inside the package is damaged. You should have received the following items inside of package:

- The unit x 1
- User manual x 1
- Communication cable x 1
- Software CD x 1

### 5.2 Preparation

Before connecting allwirings, please take off bottom cover by removing two screws as shown below.

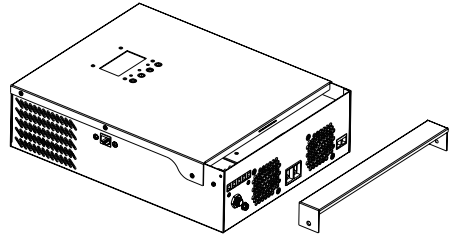

### 5.3 Mounting the unit

Consider the following points before selecting where to install:

- Do not mount the inverter on flammable construction materials.
- Mount on a solid surface.
- Install this inverter at eye level in order to allow the LCD display to be read at all times.
- For proper air circulation to dissipate heat, allow a clearance of approx. 20 cm to the side and approx. 50 cm above and below the unit.
- The ambient temperature should be between 0°C and 55°C to ensure optimal operation.
- The recommended installation position is to be adhered to the wall vertically.
- Be sure to keep other objects and surfaces as shown in the diagram to guarantee sufficient heat dissipation and to have enough space for removing wires.

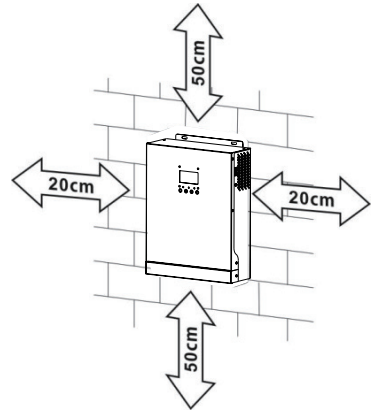

 **SUITABLE FOR MOUNTING ON CONCRETE OR NON-COMBUSTIBLE SURFACE ONLY.**

Install the unit by screwing three screws.  
It's recommended to use M4 or M5.

### 5.4 Battery connection

#### Caution:

For safety operation and regulation compliance, it's requested to install a separate DC over-current protector or disconnect device between battery and inverter. It may not be requested to have a disconnect device in some applications, however, it's still requested to have over-current protection installed. Please refer to typical amperage in below table as required fuse or breaker size.

**WARNING!** All wiring must be performed by a qualified personnel.

**WARNING!** It's very important for system safety and efficient operation to use appropriate cable for battery connection. To reduce risk of injury, please use the proper recommended cable and terminal size as below.

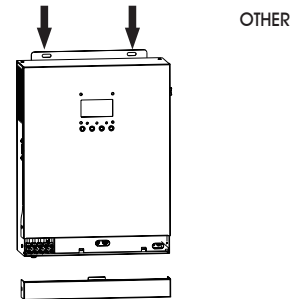

Ring terminal

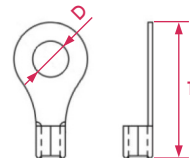

Recommended battery cable and terminal size:

Model	Input voltage	Typical amperage	Battery capacity	Wire size	Ring terminal			Torque value
					Cable mm <sup>2</sup>	Dimensions		
						D (mm)	L (mm)	
PDA3000-STATION	24V	100A	100AH 200AH	2*8AWG	14	6.4	29.2	2~3 Nm
PDA1500-STATION	12V			1*4AWG	22	6.4	33.2	
	24V	50A	100AH	1*6AWG	14	6.4	29.2	
				2*10AWG	8	6.4	23.8	

Please follow below steps to implement battery connection:

1. Assemble battery ring terminal based on recommended battery cable and terminal size.
2. PDA1500-STATION model supports 12VDC or 24VDC system. Connect all battery packs as below chart. It's suggested to connect at least 100Ah.

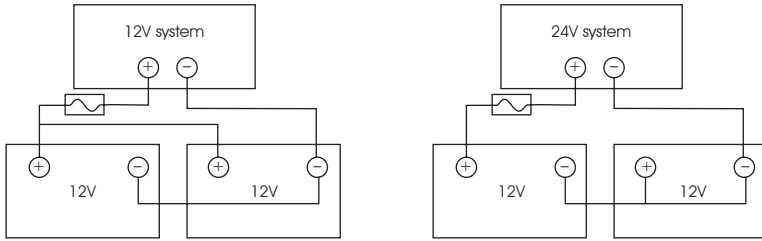

**Note:** Please only use sealed lead acid battery or sealed GEL/AGM lead-acid battery.

3. Insert the ring terminal of battery cable flatly into battery connector of inverter and make sure the bolts are tightened with torque of 2-3 Nm. Make sure polarity at both the battery and the inverter/charge is correctly connected and ring terminals are tightly screwed to the battery terminals.

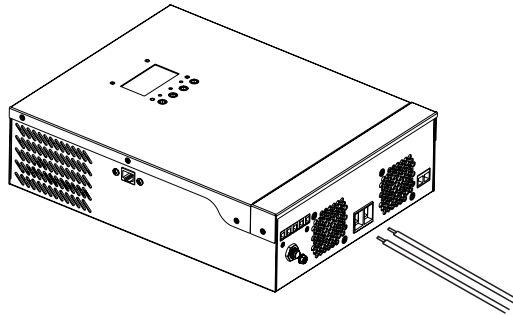

**Warning: Shock Hazard**

Installation must be performed with care due to high battery voltage in series.

**Caution!!** Do not place anything between the flat part of the inverter terminal and the ring terminal. Otherwise, overheating may occur.

**Caution!!** Do not apply anti-oxidant substance on the terminals before terminals are connected tightly.

**Caution!!** Before making the final DC connection or closing DC breaker/disconnector, be sure positive (+) must be connected to positive (+) and negative (-) must be connected to negative (-).

## 5.5 AC Input/Output connection

**Caution!!** Before connecting to AC input power source, please install a **separate** AC breaker between inverter and AC input power source. This will ensure the inverter can be securely disconnected during maintenance and fully protected from over current of AC input. The recommended spec of AC breaker is 10A for PDA1500-STATION, 32 A for PDA3000-STATION.

**Caution!!** There are two terminal blocks with "IN" and "OUT" markings. Please do NOT mis-connect input and output connectors.

**WARNING!** All wiring must be performed by a qualified personnel.

**WARNING!** It's very important for system safety and efficient operation to use appropriate cable for AC input connection. To reduce risk of injury, please use the proper recommended cable size as below.

**Suggested cable requirement for AC wires.**

Model	Gauge	Torque value
PDA1500-STATION	14AWG	0.5~0.6 Nm
PDA3000-STATION	12AWG	1.2~1.6Nm

Please follow below steps to implement AC input/output connection:

1. Before making AC input/output connection, be sure to open DC protector or disconnecter first.
2. Remove insulation sleeve 10mm for six conductors. And shorten phase L and neutral conductor N 3mm.
3. Insert AC input wires according to polarities indicated on terminal block and tighten the terminal screws.  
Be sure to connect PE protective conductor ( $\perp$ ) first.

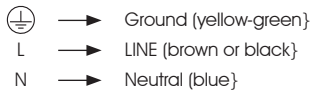

### Warning: Shock

Be sure that AC power source is disconnected before attempting to hardwire it to the unit.

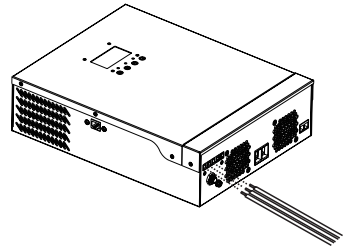

4. Then, insert AC output wires according to polarities indicated on terminal block and tighten terminal screws.

Be sure to connect PE protective conductor ( $\perp$ ) first.

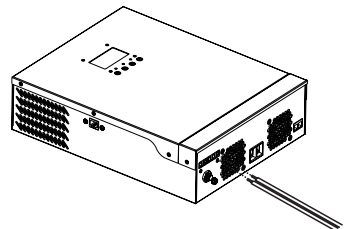
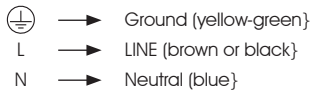

5. Make sure the wires are securely connected.

### Caution: Important!!

Be sure to connect AC wires with correct polarity. If L and N wires are connected reversely, it may cause utility short-circuited when these inverters are worked in parallel operation.

### Caution:

Appliances such as air conditioner are required at least 2~3 minutes to restart because it's required to have enough time to balance refrigerant gas inside of circuits. If a power shortage occurs and recovers in a short time, it will cause damage to your connected appliances. To prevent this kind of damage, please check manufacturer of air conditioner if it's equipped with time-delay function before installation. Otherwise, this inverter/charger will trig overload fault and cut off output to protect your appliance but sometimes it still causes internal damage to the air conditioner.

## 5.6.PV CONNECTION

### PV Module selection for MPPT mode.

Inverter model	PDA1500-STATION		PDA3000-STATION
Rated out power	12V	24V	24V
Charging current (PWM)	40A max.		
Max. PV Array open circuit voltage	102		
MPPT operating voltage range	17-80V	30-80VDC	

Take 300Wp PV module as an example. After considering above two parameters, the recommended module configurations are listed as below table.

Inverter model		PDA1500-STATION		PDA3000-STATION
Rated out power	300W	12V	24V	24V
Maximum power (Pmax)	32.75A	2 pieces in serial	2 pieces in serial and 2 sets in parallel	
Max. Power current Impp (A)	8.93A			
Open circuit voltage Voc (V)	39.84A			
Short circuit current Isc (A)	9.78A			

Please follow below steps to implement PV module connection:

1. Remove insulation sleeve 10mm for positive and negative conductors.
2. Check correct polarity of connection cable from PV modules an PV input connectors. Then, connect positive pole (+) of connection cable to positive pole (+) of PV input connector. Connect negative pole (-) of connection cable to negative pole (-) of PV input connector.
3. Make sure the wires are securely connected.

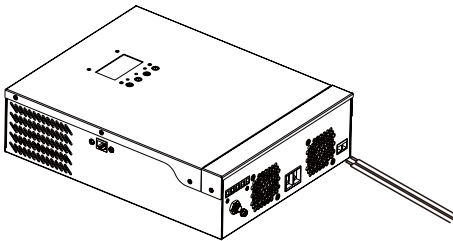
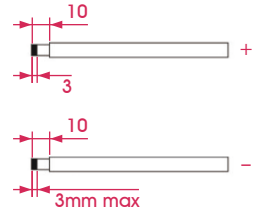

## 5.7.Final Assembly

After connecting all wirings, please put bottom cover back by screwing two screws as shown below.

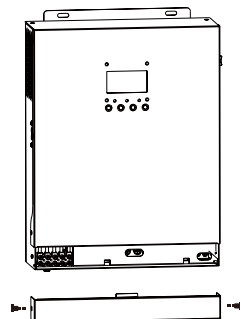



## 5.8. Communication connection

Please use supplied communication cable to connect to inverter and PC. Insert bundled CD into a computer and follow on-screen instruction to install the monitoring software. For the detailed software operation, please check user manual of software inside of CD.

## 5.9 Dry contact signal

There is one dry contact (3A/250VAC) available on the rear panel. It could be used to deliver signal to external device when battery voltage reaches warning level.

Unit status	Condition			Dry contact port: 	
				NC & C	NO & C
Power OFF	Unit is off and no output is powered.			Close	Open
Power ON	Output is powered from Utility			Close	Open
	Output is powered from Battery or Solar	Program 01 set as Utility	Battery voltage < Low DC warning voltage	Open	Close
			Battery voltage > Setting value in Program 13 or battery charging reaches floating stage	Close	Open
		Program 01 is set as SBU or Solar first	Battery voltage < Setting value in Program 12	Open	Close
			Battery voltage > Setting value in Program 13 or battery charging reaches floating stage	Close	Open

## 6. OPERATION

### 6.1 Power ON/OFF

Once the unit has been properly installed and the batteries are connected well, simply press ON/OFF switch (located on the button of the case) to turn on the unit.

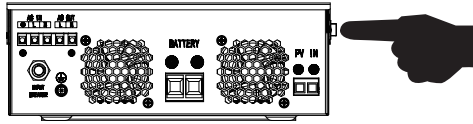

### 6.2 Operation and Display panel

The operation and display panel, shown in below chart, is on the front panel of the inverter. It includes three indicators, four function keys and a LCD display, indicating the operating status and input/output power information.

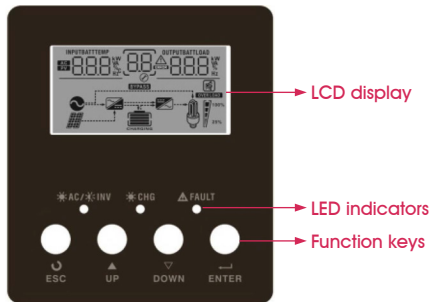

#### LED Indicator

Led indicator		Messages	
☀ AC / ⚡ INV	Green	Solid ON	Output is powered by utility in Line mode.
		Flashing	Output is powered by battery or PV in battery mode.
☀ CHG	Green	Solid ON	Battery is fully charged.
		Flashing	Battery is charging.
⚠ FAULT	Red	Solid ON	Fault occurs in the inverter.
		Flashing	Warning condition occurs in the inverter.

#### Function KEYS

Function Key	Description
ESC	To exit setting mode.
UP	To go to previous selection.
DOWN	To go to next selection.
ENTER	To confirm the selection in setting mode or enter setting mode.

### 6.3 LCD Display Icons

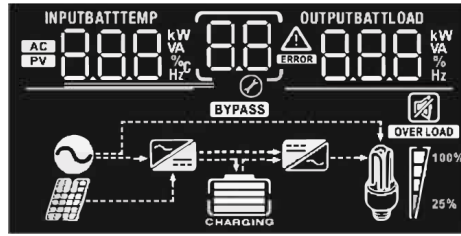

Icon		Function description
Input source information		
		Indicates the AC input.
		Indicates the PV input.
		Indicate input voltage, input frequency, PV voltage, battery voltage and charger current.
Configuration program and fault information		
		Indicates the setting programs.
		Indicates the warning and fault codes. <b>Warning:</b> flashing with warning code. <b>Fault:</b> lighting with fault code.
Output information		
		Indicate output voltage, output frequency, load percent, load in VA, load in Watt and discharging current.
Battery information		
		Indicates battery level by 0-24%, 25-49%, 50-74% and 75-100% in battery mode and charging status in line mode.
<b>In AC mode, it will present battery charging status.</b>		
Status	Battery voltage	LCD Display
Constant current mode / Constant voltage mode	<2V/cell	4 bars will flash in turns.
	2 ~ 2.083V/cell	Bottom bar will be on and the other three bars will flash in turns.
	2.083 ~ 2.167V/cell	Bottom two bars will be on and the other two bars will flash in turns.
	2.167V/cell	Bottom three bars will be on and the top bar will flash.
Floating mode. Batteries are fully charged.		4 bars will be on.

In battery mode, it will present battery capacity.		
Load percentage	Battery voltage	LCD Display
Load>50%	<1.717V/cell	
	1.717V/cell ~ 1.8V/cell	
	1.8 ~ 1.883V /cell	
	> 1.883 V /cell	
50%>Load >20%	<1.817V/cell	
	1.817V/cell ~ 1.9V/cell	
	1.9 ~ 1.983V/cell	
	> 1.983	
Load<20%	<1.867V /cell	
	1.867V/cell ~ 1.95V/cell	
	1.95 ~ 2.033V/cell	
	>2.033	

Load information				
	Indicates overload.			
  100% 25%	Indicates the load level by 0-24%, 25-50%, 50-74% and 75-100%.			
	0%~25%	25%~50%	50%~75%	75%~100%
Mode operation information				
	Indicates unit connects to the mains.			
	Indicates unit connects to the PV panel.			
	Indicates load is supplied by utility power.			
	Indicates the utility charger circuit is working.			
	Indicates the DC/AC inverter circuit is working.			
Mute operation				
	Indicates unit alarm is disabled.			

## 6.4 LCD Settings











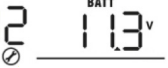

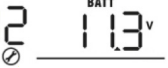

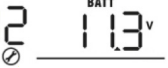
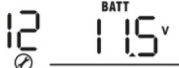
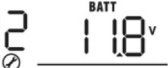
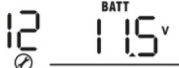
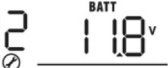
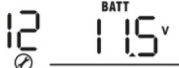
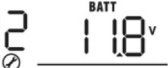











































After pressing and holding ENTER button for 3 seconds, the unit will enter setting mode. Press "UP" or "DOWN" button to select setting programs. And then, press "ENTER" button to confirm the selection or ESC button to exit.

Setting Programs			
Program	Description	Selectable option	
00	Exit setting mode	Escape 00 ESC	
01	Output source priority: To configure load power source priority	Solar first 01 SOL	Solar energy provides power to the loads as first priority. If solar energy is not sufficient to power all connected loads, battery energy will supply power the loads at the same time. Utility provides power to the loads only when any one condition happens: - Solar energy is not available - Battery voltage drops to low-level warning voltage or the setting point in program 12.
		Utility first (default) 01 UTI	Utility will provide power to the loads as first priority. Solar and battery energy will provide power to the loads only when utility power is not available.
		SBU priority 01 SBU	Solar energy provides power to the loads as first priority. If solar energy is not sufficient to power all connected loads, battery energy will supply power to the loads at the same time. Utility provides power to the loads only when battery voltage drops to either low-level warning voltage or the setting point in program 12.
02	Maximum charging current: To configure total charging current for solar and utility chargers. (Max. charging current = utility charging current + solar charging current)	10A (Only available for PDA1500-STATION (12V) model) 02 10 A	20A 02 20 A
		30A 02 30 A	40A 02 40 A
		50A 02 50 A	60A 02 60 A
		70A 02 70 A	80A (Only for PDA3000-STATION model) 02 80 A



















## Setting Programs

Program	Description	Selectable option	
03	AC input voltage range	Appliances (default) 03 <u>APL</u>	If selected, acceptable AC input voltage range will be within 90-280VAC.
		UPS 03 <u>UPS</u>	If selected, acceptable AC input voltage range will be within 170-280VAC.
04	Power saving mode enable/disable	Saving mode disable (default) 04 <u>SdS</u>	If disabled, no matter connected load is low or high, the on/off status of inverter output will not be effected.
		Saving mode enable 04 <u>SEN</u>	If enabled, the output of inverter will be off when connected load is pretty low or not detected.
05	Battery type	AGM (default) 05 <u>AGM</u>	Flooded
		User-Defined 05 <u>USE</u>	If "User-Defined" is selected, battery charge voltage and low DC cut-off voltage can be set up in program 26, 27 and 29.
06	Auto restart when overload occurs	Restart disable (default) 06 <u>Ltd</u>	Restart enable 06 <u>LtE</u>
07	Auto restart when over temperature occurs	Restart disable (default) 07 <u>ttd</u>	Restart enable 07 <u>tEt</u>
09	Output frequency	50Hz (default) 09 <u>50</u> Hz	60Hz 09 <u>60</u> Hz
11	Maximum utility charging current. <b>Note:</b> If setting value in program 02 is smaller than that in program in 11, the inverter will apply charging current from program 02 for utility charger.	Available options in PDA1500-STATION (12V) model:	
		10A 11 <u>10A</u>	20A (default) 11 <u>20A</u>
		Available options in PDA1500-STATION (24V) / PDA3000-STATION model:	
		20A 11 <u>20A</u>	30A (default) 11 <u>30A</u>

## Setting Programs







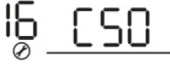

Program	Description	Selectable option		
12	Setting voltage point back to utility source when selecting "SBU priority" or "Solar first" in program 01.	Available options in PDA1500-STATION (12V) model:		
		<table style="width: 100%; border-collapse: collapse;"> <tr> <td style="width: 50%; text-align: center;">                     11.0V   </td> <td style="width: 50%; text-align: center;">                     11.3V   </td> </tr> </table>	11.0V 	11.3V 
		11.0V 	11.3V 	
		<table style="width: 100%; border-collapse: collapse;"> <tr> <td style="width: 50%; text-align: center;">                     11.5V (default)   </td> <td style="width: 50%; text-align: center;">                     11.8V   </td> </tr> </table>	11.5V (default) 	11.8V 
		11.5V (default) 	11.8V 	
		<table style="width: 100%; border-collapse: collapse;"> <tr> <td style="width: 50%; text-align: center;">                     12.0V   </td> <td style="width: 50%; text-align: center;">                     12.3V   </td> </tr> </table>	12.0V 	12.3V 
		12.0V 	12.3V 	
		<table style="width: 100%; border-collapse: collapse;"> <tr> <td style="width: 50%; text-align: center;">                     12.5V   </td> <td style="width: 50%; text-align: center;">                     12.8V   </td> </tr> </table>	12.5V 	12.8V 
		12.5V 	12.8V 	
		Available options in PDA1500-STATION (24V) / PDA3000-STATION model:		
<table style="width: 100%; border-collapse: collapse;"> <tr> <td style="width: 50%; text-align: center;">                     22.0V   </td> <td style="width: 50%; text-align: center;">                     22.5V   </td> </tr> </table>	22.0V 	22.5V 		
22.0V 	22.5V 			
<table style="width: 100%; border-collapse: collapse;"> <tr> <td style="width: 50%; text-align: center;">                     23.0V (default)   </td> <td style="width: 50%; text-align: center;">                     23.5V   </td> </tr> </table>	23.0V (default) 	23.5V 		
23.0V (default) 	23.5V 			
<table style="width: 100%; border-collapse: collapse;"> <tr> <td style="width: 50%; text-align: center;">                     24.0V   </td> <td style="width: 50%; text-align: center;">                     24.5V   </td> </tr> </table>	24.0V 	24.5V 		
24.0V 	24.5V 			
<table style="width: 100%; border-collapse: collapse;"> <tr> <td style="width: 50%; text-align: center;">                     25.0V   </td> <td style="width: 50%; text-align: center;">                     25.5V   </td> </tr> </table>	25.0V 	25.5V 		
25.0V 	25.5V 			
13	Setting voltage point back to battery mode when selecting "SBU priority" or "Solar first" in program 01.	Available options in PDA1500-STATION (12V) model:		
		<table style="width: 100%; border-collapse: collapse;"> <tr> <td style="width: 50%; text-align: center;">                     Battery fully charged   </td> <td style="width: 50%; text-align: center;">                     12.0V   </td> </tr> </table>	Battery fully charged 	12.0V 
		Battery fully charged 	12.0V 	
		<table style="width: 100%; border-collapse: collapse;"> <tr> <td style="width: 50%; text-align: center;">                     12.3V   </td> <td style="width: 50%; text-align: center;">                     12.5V   </td> </tr> </table>	12.3V 	12.5V 
12.3V 	12.5V 			
<table style="width: 100%; border-collapse: collapse;"> <tr> <td style="width: 50%; text-align: center;">                     12.8V   </td> <td style="width: 50%; text-align: center;">                     13.0V   </td> </tr> </table>	12.8V 	13.0V 		
12.8V 	13.0V 			

## Setting Programs



Program	Description	Selectable option	
13	Setting voltage point back to battery mode when selecting "SBU priority" or "Solar first" in program 01.	13.3V 	13.5V (default) 
		13.8V 	14.0V 
		14.3V 	14.5V 
		Available options in PDA1500-STATION (24V) / PDA3000-STATION model:	
		Battery fully charged 	24V 
		24.5V 	25V 
		25.5V 	25V 
		26.5V 	27V (default) 
		27.5V 	28V 
		28.5V 	28V 

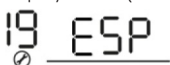
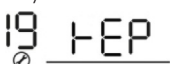
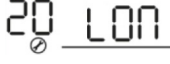
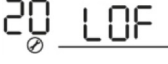
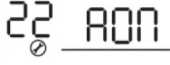

## Setting Programs

Program	Description	Selectable option	
16	Charger source priority: To configure charger source priority	If this inverter/charger is working in Line, Standby or Fault mode, charger source can be programmed as below:	
		Solar first 	Solar energy will charge battery as first priority. Utility will charge battery only when solar energy is not available.
		Utility first 	Utility will charge battery as first priority. Solar energy will charge battery only when utility power is not available.
		Solar and Utility 	Solar energy and utility will charge battery at the same time.
		Only Solar 	Solar energy will be the only charger source no matter utility is available or not.
		If this inverter/charger is working in Battery mode or Power saving mode, only solar energy can charge battery. Solar energy will charge battery if it's available and sufficient.	
18	Alarm control	Alarm on (default) 	Alarm off 
19	Auto return to default display screen	Return to default display screen (default) 	If selected, no matter how users switch display screen, it will automatically return to default display screen (Input voltage / output voltage) after no button is pressed for 1 minute.
		Stay at latest screen 	If selected, the display screen will stay at latest screen user finally switches.
20	Backlight control	Backlight on (default) 	Backlight off 
22	Beeps while primary source is interrupted	Alarm on (default) 	Alarm off 

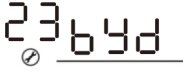
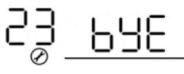
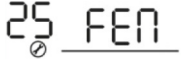
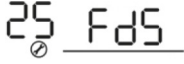
## Setting Programs

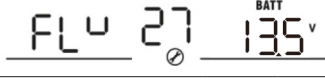
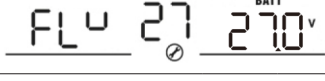
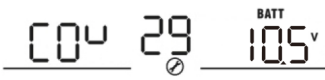
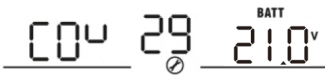
Program	Description	Selectable option	
23	Overload bypass: When enabled, the unit will transfer to line mode if overload occurs in battery mode.	Bypass disable (default) 	Bypass enable 
25	Record fault code	Record enable 	Record disable (default) 
26	Bulk charging voltage (C.V voltage)	PDA1500-STATION (12V) model default setting: 14.1V 	
		PDA1500-STATION (24V) / PDA3000-STATION model default setting: 28.2V 	
		If self-defined is selected in program 5, this program can be set up. Setting range is from 12.0V to 14.6V for PDA1500-STATION (12V) model, 24.0V to 29.2V for PDA3000-STATION model. Increment of each click is 0.1V.	
27	Floating charging voltage	PDA1500-STATION (12V) model default setting: 13.5V 	
		PDA1500-STATION (24V) / PDA3000-STATION model default setting: 27.0V 	
		If self-defined is selected in program 5, this program can be set up. Setting range is from 12.0V to 14.6V for PDA1500-STATION (12V) model; 24.0V to 29.2V for PDA1500-STATION (24V) / PDA3000-STATION model. Increment of each click is 0.1V.	
29	Low DC cut-off voltage	PDA1500-STATION (12V) model default setting: 10.5V 	
		PDA1500-STATION (24V) / PDA3000-STATION model default setting: 21.0V 	
		If self-defined is selected in program 5, this program can be set up. Setting range is from 10.0V to 12.0V for PDA1500-STATION (12V) model, 20.0V to 24.0V for PDA1500-STATION (24V) / PDA3000-STATION model. Increment of each click is 0.1V. Low DC cut-off voltage will be fixed to setting value no matter what percentage of load is connected.	

## Setting Programs

Program	Description	Selectable option	
33	Battery equalization		
		If "Flooded" or "User-Defined" is selected in program 05, this program can be set up.	
34	Battery equalization voltage	PDA1500-STATION (12V) model default setting: 14.6V	
		Setting range is from 12.5V to 15V. Increment of each click is 0.1V.	
		PDA1500-STATION (24V) / PDA3000-STATION model default setting: 29.2V	
		Setting range is from 25.0V to 30V. Increment of each click is 0.1V.	
35	Battery equalized time	60min (default)	Setting range is from 5min to 900min. Increment of each click is 5min.
36	Battery equalized timeout	120min (default)	Setting range is from 5min to 900 min. Increment of each click is 5 min.
37	Equalization interval	30 days (default)	Setting range is from 0 to 90 days. Increment of each click is 1 day
39	Equalization activated immediately	Enable	Disable (default)
		If equalization function is enabled in program 30, this program can be set up. If "Enable" is selected in this program, it's to activate battery equalization immediately and LCD main page will shows EQ. If "Disable" is selected, it will cancel equalization function until next activated equalization time arrives based on program 35 setting. At this time, EQ will not be shown in LCD main page.	







## 6.5 Display Settings

The LCD display information will be switched in turns by pressing "UP" or "DOWN" key. The selectable information is switched as below order: input voltage, input frequency, PV voltage, charging current, battery voltage, output voltage, output frequency, load percentage, load in Watt, load in VA, load in Watt, DC discharging current, main CPU Version and second CPU Version.

Selectable information	LCD display
Input voltage/Output voltage (Default Display Screen)	<p>Input Voltage=230V, output voltage=230V</p>
Input frequency	<p>Input frequency=50Hz</p>
PV voltage	<p>PV voltage=60V</p>
Charging current	<p>Charging current=50A</p>
Battery voltage/DC discharging current	<p>Battery voltage=25.5V, discharging current=1A</p>
Output frequency	<p>Output frequency=50Hz</p>

Selectable information	LCD display
Load percentage	<p>Load percent = 70%</p>
Load in VA	<p>When connected load is lower than 1kVA, load in VA will present xxxVA like below chart.</p> <p>When load is larger than 1kVA (<math>\geq 1\text{kVA}</math>), load in VA will present x.xxkVA like below chart.</p>
Load in Watt	<p>When load is lower than 1kW, load in W will present xxxW like below chart.</p> <p>When load is larger than 1kW (<math>\geq 1\text{kW}</math>), load in W will present x.xxkW like below chart.</p>
Main CPU version checking	<p>Main CPU version 00014.04.</p>

## 6.6 Operating mode description

Operation mode	Description	LCD display
<p><b>Standby mode / Power saving mode</b></p> <p><b>Note:</b></p> <ul style="list-style-type: none"> <li>* <b>Standby mode:</b> The inverter is not turned on yet but at this time, the inverter can charge battery without AC output.</li> <li>* <b>Power saving mode:</b> If enabled, the output of inverter will be off when connected load is pretty low or not detected.</li> </ul>	<p>No output is supplied by the unit but it still can charge batteries.</p>	<p>Charging by utility and PV energy.</p> 
		<p>Charging by utility.</p> 
		<p>Charging by PV energy.</p> 
		<p>No charging.</p> 
<p><b>Fault mode</b></p> <p><b>Note:</b></p> <ul style="list-style-type: none"> <li>* <b>Fault mode:</b> Errors are caused by inside circuit error or external reasons such as over temperature, output short circuited and so on.</li> </ul>	<p>PV energy and utility can charge batteries.</p>	<p>Charging by utility and PV energy.</p> 
		<p>Charging by utility.</p> 
		<p>Charging by PV energy.</p> 

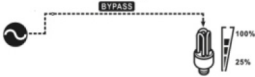
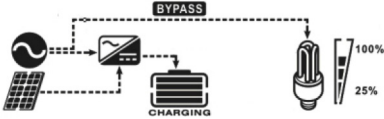
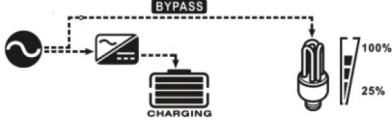
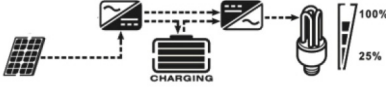
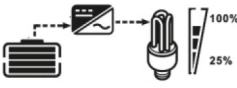
Operation mode	Description	LCD display
<p><b>Fault mode</b></p> <p><b>Note:</b></p> <p>* <b>Fault mode:</b> Errors are caused by inside circuit error or external reasons such as over temperature, output short circuited and so on.</p>	<p>PV energy and utility can charge batteries.</p>	<p>No charging</p> 
	<p>Utility can power loads when the unit starts up without battery.</p>	<p>Power from utility</p> 
<p>Line Mode</p>	<p>The unit will provide output power from the mains. It will also charge the battery at line mode.</p>	<p>Charging by utility and PV energy.</p>  <p>Charging by utility</p> 
<p>Battery mode</p>	<p>The unit will provide output power from battery and PV power.</p>	<p>Power from battery and PV energy.</p>  <p>Power from battery only.</p> 

## Battery equalization description

Equalization function is added into charge controller. It reverses the buildup of negative chemical effects like stratification, a condition where acid concentration is greater at the bottom of the battery than at the top. Equalization also helps to remove sulfate crystals that might have built up on the plates. If left unchecked, this condition, called sulfation, will reduce the overall capacity of the battery. Therefore, it's recommended to equalize battery periodically.

### How to apply equalization function

You must enable battery equalization function in monitoring LCD setting program 30 first. Then, you may apply this function in device by either one of following methods:

1. Setting equalization interval in program 35.
2. Active equalization immediately in program 36.

### When to equalizer

In float stage, when the setting equalization interval (battery equalization cycle) is arrived, or equalization is active immediately, the controller will start to enter Equalize stage.

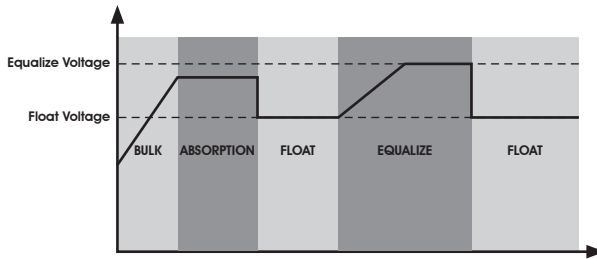

### Equalize charging time and timeout

In Equalize stage, the controller will supply power to charge battery as much as possible until battery voltage raises to battery equalization voltage. Then, constant-voltage regulation is applied to maintain battery voltage at the battery equalization voltage. The battery will remain in the Equalize stage until setting battery equalized time is arrived.

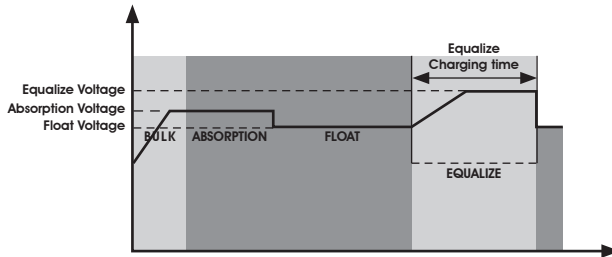



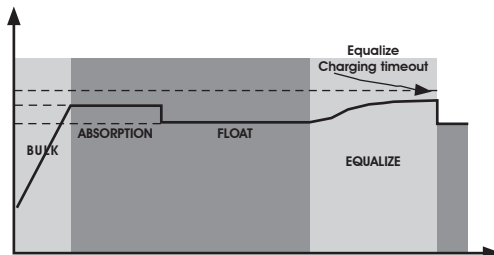







However, in Equalize stage, when battery equalized time is expired and battery voltage doesn't rise to battery equalization voltage point, the charge controller will extend the battery equalized time until battery voltage achieves battery equalization voltage. If battery voltage is still lower than battery equalization voltage when battery equalized timeout setting is over, the charge controller will stop equalization and return to float stage.













## 6.7 Fault reference code

Fault code	Fault Event	Icon on
01	Fan is locked when inverter is OFF.	
02	Over temperature.	
03	Battery voltage is too high.	
04	Battery voltage is too low.	
05	Output short circuited or over temperature is detected by internal converter components.	
06	Output voltage is abnormal.	
07	Overload time out.	
08	Bus voltage is too high.	
09	Bus soft start failed.	
11	Main relay failed.	

## 6.8 Warning indicator

Warning code	Warning event	Audible alarm	Icon flashing
01	Fan is locked when inverter is ON.	Beep three times every second.	
03	Battery is over-charged.	Beep once every second.	
04	Low battery.	Beep once every second.	
07	Overload.	Beep once every 0.5 second.	
10	Output power derating.	Beep twice every 3 seconds.	
12	Solar charger stops due to low battery.		
13	Solar charger stops due to high PV voltage.		
14	Solar charger stops due to overload.		
E9	Battery equalization		

## 7. SPECIFICATIONS

**Table 1 - Line mode specifications**

Inverter model	PDA1 500-STATION		PDA3000-STATION
Input voltage	12V	24V	24V
Input voltage waveform	Sinusoidal (utility or generator)		
Nominal input voltage	230Vac		
Low loss voltage	170Vac $\pm$ 7V (UPS); 90Vac $\pm$ 7V (Appliances)		
Low loss return voltage	180Vac $\pm$ 7V (UPS); 100Vac $\pm$ 7V (Appliances)		
High loss voltage	280Vac $\pm$ 7V		
High loss return voltage	270Vac $\pm$ 7V		
Max AC input voltage	300Vac		
Nominal input frequency	50Hz / 60Hz (Auto detection)		
Low loss frequency	40 $\pm$ 1Hz		
Low loss return frequency	42 $\pm$ 1Hz		
High loss frequency	65 $\pm$ 1Hz		
High loss return frequency	63 $\pm$ 1Hz		
Output short circuit protection	Circuit Breaker		
Efficiency (Line mode)	95% (Rated R load, battery full charged)		
Transfer time	10ms typical (UPS); 20ms typical (Appliances)		
Output power derating: When AC input voltage drops to 170V, the output power will be derated.	<p>The graph illustrates the output power derating characteristic. The vertical axis represents Output power, with a horizontal dashed line for Rated power and a lower horizontal dashed line for 50% power. The horizontal axis represents Input voltage, with markers at 90V, 170V, and 280V. The power remains constant at the Rated level from 170V up to 280V. Between 170V and 90V, the power decreases linearly to 50% of the Rated power. Below 90V, the output power is zero.</p>		

**Table 2 - Inverter mode specifications**

Inverter model	PDA1500-STATION		PDA3000-STATION
Nominal DC input voltage	12V	24V	24V
Rated output power	1200W		2400W
Output voltage waveform	Pure sine wave		
Output voltage regulation	230Vac±5%		
Output frequency	50Hz		
Peak efficiency	95%		
Overload protection	5s@≥c150% load; 10s@110%~150% load		
Surge capacity	2*rated power for 5 seconds		
Cold start voltage	11.5Vdc	23.0Vdc	
Low DC Warning voltage			
@load<20%	11.0Vdc	22.0Vdc	
@20%≤load<50%	10.7Vdc	21.4Vdc	
@load≥50%	10.1Vdc	20.2Vdc	
Low DC Warning return voltage			
@load<20%	10.5Vdc	21.0Vdc	
@20%≤load<50%	10.2Vdc	20.4Vdc	
@load≥50%	9.6Vdc	19.2Vdc	
High DC cut-off voltage	15.5Vdc	31.0Vdc	
No load power consumption	<15W		<20W
Saving mode power consumption	<5W		<10W

**Table 3 - Inverter mode specifications**

Inverter model		PDA1 500-STATION		PDA3000-STATION
Nominal DC input voltage		12V	24V	24V
Charging algorithm		3-step		
AC Charging current		10/20Amp	20/30Amp (@ $V_{VP}=230Vac$ )	
Bulk charging voltage	Flooded battery	14.6	29.2	
	AGM / Gel battery	14.1	28.2	
Floating charging voltage		13.5Vdc	27Vdc	
Charging curve		<p>The graph plots Battery voltage, per cell (left y-axis) and Charge current, % (right y-axis) against Time (x-axis). The voltage curve (black) starts at 2.25Vdc, rises to 2.43Vdc (2.35Vdc) during the BULK phase (constant current, duration <math>T_0</math>), remains constant during the ABSORPTION phase (constant voltage, duration <math>T_1</math>), and then drops to 2.25Vdc during the MAINTENANCE phase (floating). The current curve (red) starts at 100% and decreases to 0% over time. <math>T_3 = 10 \cdot T_0</math>, minimum 10mins, maximum 8hrs.</p>		

**Table 4 - General specifications**

Inverter model	PDA1 500-STATION		PDA3000-STATION
Rated out power	12V	24V	24V
Max. current	40A max.		
Max. PV array open circuit voltage	102V		
MPPT operating voltage range	17-80V	30-80V	
Max. charging current (utility charging + solar charging)	60A	70A	

## 8. TROUBLE SHOOTING

Problem	LCD / LED / Buzzer	Explanation / Possible cause	What to do
Unit shuts down automatically during startup process.	LCD/LEDs and buzzer will be active for 3 seconds and then complete off.	The battery voltage is too low (<1.91V/Cell) .	1. Re-charge battery. 2. Replace battery.
No response after power on.	No indication.	1. The battery voltage is far too low. (<1.4V/Cell) 2. Battery polarity is connected reversed.	1. Check if batteries and the wiring are connected well. 2. Re-charge battery. 3. Replace battery.
Mains exist but the unit works in battery mode.	Input voltage is displayed as 0 on the LCD and green LED is flashing.	Input protector is tripped.	Check if AC breaker is tripped and AC wiring is connected well.
	Green LED is flashing.	Insufficient quality of AC power. (Shore or Generator).	1. Check if AC wires are too thin and/or too long. 2. Check if generator (if applied) is working well or if input voltage range setting is correct. (UPS → Appliance)
	Green LED is flashing.	Set "Solar First" as the priority of outout source.	Change output source priority to Utility first.
When the unit is turned on, internal relay is switched on and off repeatedly.	LCD display and LEDs are flashing.	Battery is disconnected.	Check if battery wires are connected well.
Buzzer beeps continuously and red LED is on.	Fault code 07.	Overload error. The inverter is overload 110% and time is up.	Reduce the connected load by switching off some equipment.
	Fault code 05.	Output short circuited.	Check if wiring is connected well an remove abnormal load.
		Temperature of internal converter component is over 120°C.	Check whether the air flow of the unit is blocked or whether the ambient temperature is too high.
	Fault code 02.	Internal temperature of inverter component is over 100°C.	
	Fault code 03.	Battery is over-charged.	Return to repair center.
		The battery voltage is too high.	Check if spec and quantity of batteries are meet requirements.
	Fault code 01.	Fan fault.	Replace the fan.
	Fault code 06.	Output abnormal (inverter voltage below than 190Vac or is higher than 260VAC).	1. Reduce the connected load. 2. Return to reodair center.
Fault code 08/09.	Internal components failed.	Return to repair center.	

## 9. APPENDIX: Approximate Back-up Time Table

Model	Load (VA)	Backup Time @ 12Vdc 100Ah (min)	Backup Time @ 12Vdc 200Ah (min)
PDA1500-STATION (12V)	100	766	1610
	200	335	766
	300	198	503
	400	139	339
	500	1112	269
	600	95	227
	700	81	176
	800	62	140
	900	55	125
	1000	50	112
PDA1500-STATION (24V) PDA3000-STATION	300	449	1100
	600	222	525
	900	124	303
	1200	95	227
	1500	68	164
	1800	56	126
	2100	48	108
	2400	35	94
	2700	31	74
	3000	28	67

**Note:** Backup time depends on the quality of the battery, age of battery and type of battery. Specifications of batteries may vary depending on different manufacturers.



# fullwat.com



Agente importador  
A48.139.786  
UKAI S.A.  
Ribera de Elorrieta, 7C  
48015 - Bilbao - SPAIN  
Designed in EU - Made in PRC