

UL 12 - 6

6V 12AH

STANDBY

Ultracell®

'Quality in Every Language'

Image



Terminal Type

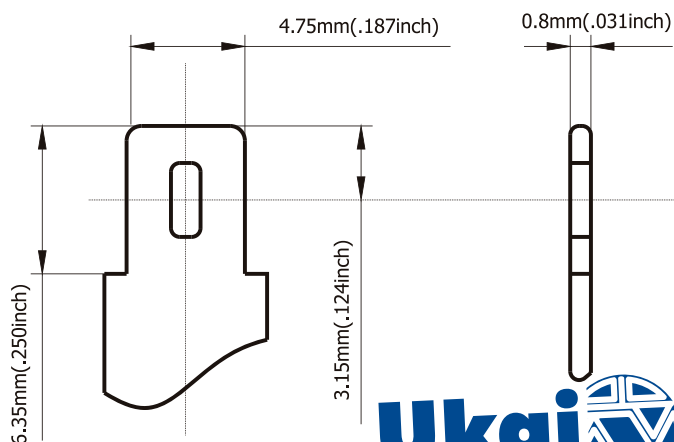

Dimensions

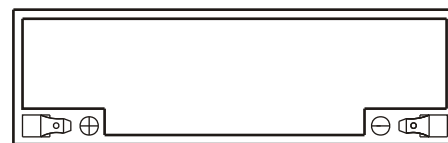
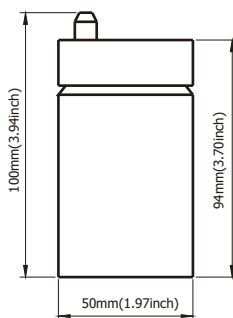
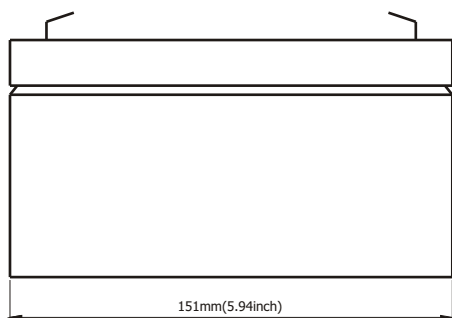

Ribera Elorrieta, 7C
48015 - Bilbao
Teléfono: 94 474 52 52
Fax: 94 475 97 10
E-mail: ukai@ukai.com

Specifications

Battery Model	UL 12 - 6			
Designed Floating Life	5 Years			
Capacity (25°C)	20HR (0.6A, 1.75V)	10HR (1.14A, 1.75V)	5HR (2.04A, 1.75V)	1HR (7.2A, 1.55V)
	12AH	11.4AH	10.2AH	7.2AH
Dimensions	Length	Width	Height	Total Height
	151mm	50mm	94mm	100mm
Approx. Weight	1.85Kg			
Internal Resistance	Fully Charged at 25°C 0.010 Ohm			
Self Discharge	3% of capacity declined per month at 25°C			
Capacity Affected by Temperature	40°C	25°C	0°C	-15°C
	102%	100%	85%	65%
Charge Voltage (25°C)	Cycle Use		Float Use	
	7.2 - 7.5V (-12mV/C), max. Current: 3.6A		6.75 - 6.9V (-9mV/C)	

Construction

Component — Raw material
Positive — Lead dioxide
Negative — Lead
Container — ABS (Flame Retardent optional)
Cover — ABS (Flame Retardent optional)

Sealed and maintenance free option

Sealant — Epoxy Resin
Safety Valve — EPDR
Terminal — Copper
Separator — Fibre Glass
Electrolyte — Sulphuric acid

Non-spillable construction design



UKAI BILBAO
Ribera Elorrieta 7C
48015 Bilbao
Teléfono: 94 474 5252
Fax: 94 475 9710
e-mail: ukai@ukai.com

UKAI BARCELONA
C/ Orient 78-84 1º 7ª (Ed. Inbisa)
08011 St. Cugat del Vallés
Teléfono: 93 284 0898
Fax: 93 210 6765
e-mail: ukaibcn@ukai.com

UKAI MADRID
Avda Andalucía 2, 2ª planta local 211
28702 San Sebastián de los Reyes
Teléfono: 91 659 0328
Fax: 91 659 0558
e-mail: ukaimad@ukai.com

UL 12 - 6

6V 12AH

STANDBY

Ultracell®

'Quality in Every Language'

Charge Characteristic

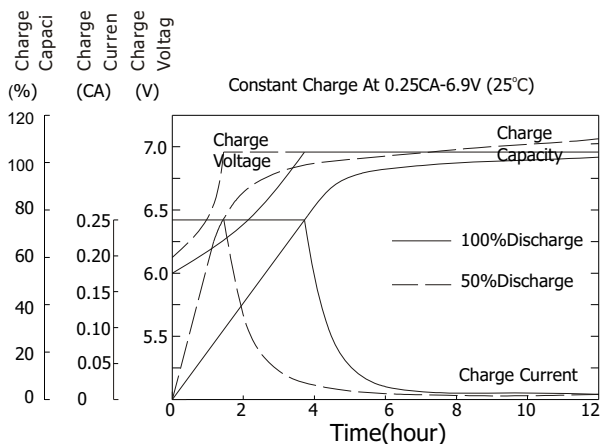

Discharge Characteristic 25°C

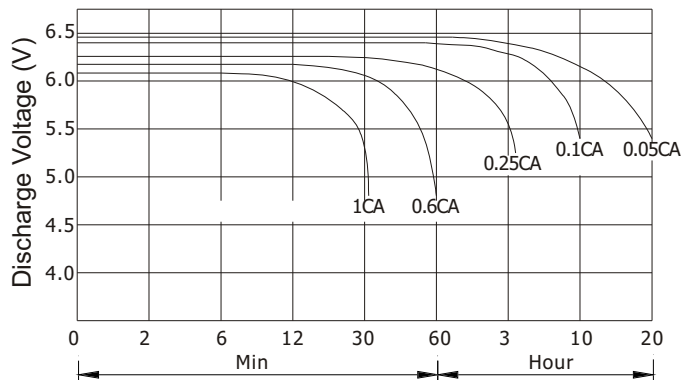

Relationship of OCV and state of charge

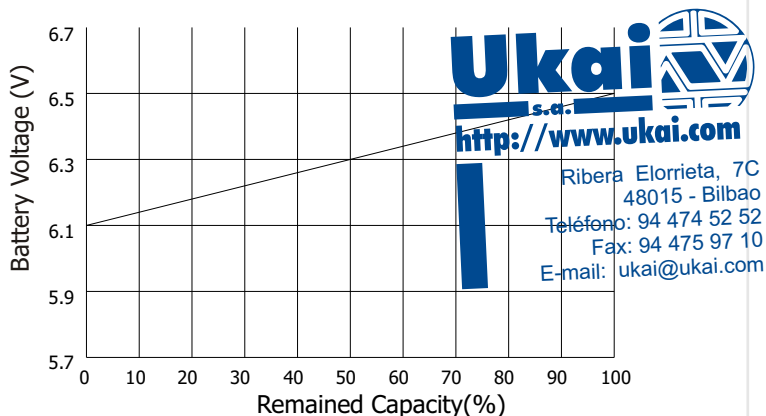

Self Discharge Characteristics

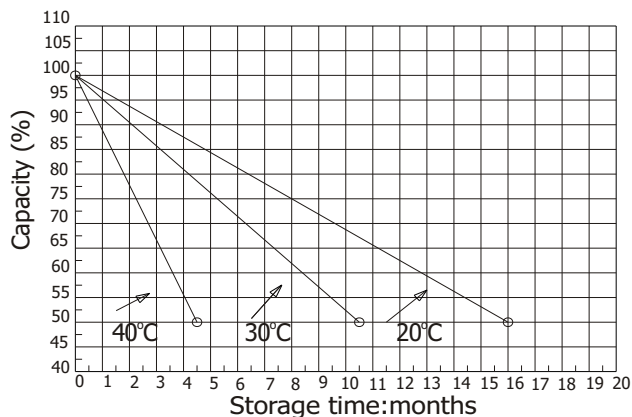

Constant Current Discharge Ratings - amperes at 25°C

F.V / Time	5 MIN	10 MIN	15 MIN	30 MIN	1 HR	3 HR	5 HR	10 HR	20 HR
1.60 V	46.9	29.3	22.0	13.4	7.20	3.74	2.29	1.27	0.66
1.67 V	44.1	27.6	21.3	12.8	7.18	3.58	2.25	1.25	0.64
1.70 V	40.5	26.7	20.7	11.7	7.02	3.00	2.18	1.20	0.63
1.75 V	39.7	25.8	20.0	11.3	6.88	3.26	2.04	1.14	0.60
1.80 V	35.5	24.9	18.4	10.4	6.70	3.15	2.02	1.13	0.59
1.85 V	31.3	23.9	16.5	9.47	6.62	3.08	1.99	1.12	0.58

Constant Power Discharge Ratings - watts at 25°C

F.V / Time	5 MIN	10 MIN	15 MIN	30 MIN	1 HR	3 HR	5 HR	10 HR	20 HR
1.60 V	96.0	62.5	48.0	27.6	15.6	6.08	4.13	2.30	1.22
1.67 V	92.6	61.2	47.1	27.4	15.5	6.04	4.12	2.30	1.21
1.70 V	89.0	59.8	46.0	27.0	15.3	6.01	4.10	2.29	1.21
1.75 V	83.8	57.7	44.7	26.4	15.0	6.00	4.08	2.28	1.20
1.80 V	72.4	53.3	42.7	25.4	14.6	5.83	4.06	2.25	1.20
1.85 V	62.4	52.2	41.0	23.6	13.7	5.67	4.00	2.25	1.19



UKAI BILBAO
 Ribera Elorrieta 7C
 48015 Bilbao
 Teléfono: 94 474 5252
 Fax: 94 475 9710
 e-mail: ukai@ukai.com

UKAI BARCELONA
 C/ Orient 78-84 1º 7ª (Ed. Inbisa)
 08011 St. Cugat del Vallés
 Teléfono: 93 284 0898
 Fax: 93 210 6765
 e-mail: ukaibcn@ukai.com

UKAI MADRID
 Avda Andalucía 2, 2ª planta local 211
 28702 San Sebastián de los Reyes
 Teléfono: 91 659 0328
 Fax: 91 659 0558
 e-mail: ukaimad@ukai.com