

UL 7 - 12
12V 7AH
STANDBY

Ultracell®

'Quality in Every Language'

Image



Terminal Type

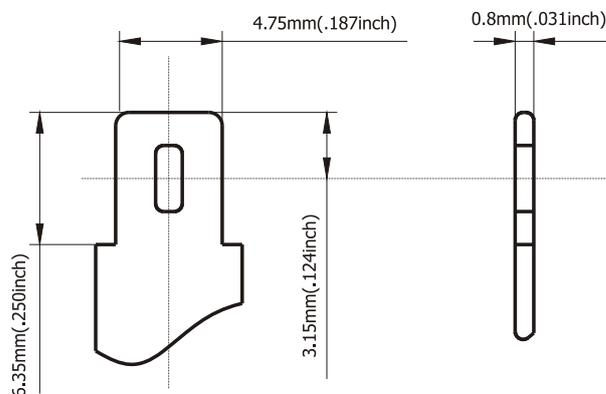

Dimensions

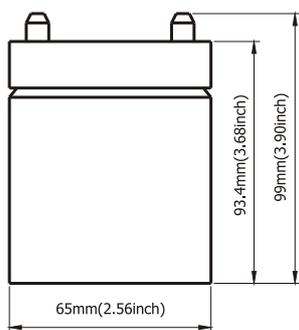
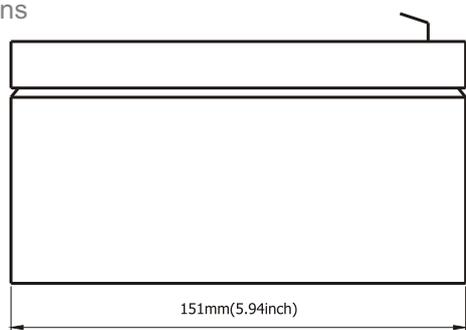

Ukai
s.a.
<http://www.ukai.com>
Ribera Elorrieta, 7C
48015 - Bilbao
Teléfono: 94 474 52 52
Fax: 94 475 97 10
E-mail: ukai@ukai.com

Specifications

Battery Model	UL 7 - 12			
Designed Floating Life	5 Years			
Capacity (25°C)	20HR (0.35A, 1.75V)	10HR (0.665A, 1.75V)	5HR (1.19A, 1.75V)	1HR (4.2A, 1.55V)
	7AH	6.65AH	5.95AH	4.2AH
Dimensions	Length	Width	Height	Total Height
	151mm	65mm	93.4mm	99mm
Approx. Weight	2.05Kg			
Internal Resistance	Fully Charged at 25°C 0.028Ohm			
Self Discharge	3% of capacity declined per month at 25°C			
Capacity Affected by Temperature	40°C	25°C	0°C	-15°C
	102%	100%	85%	65%
Charge Voltage (25°C)	Cycle Use		Float Use	
	14.0-15.0V (-24mV/C), max. Current: 2.1A		13.6-13.8V (-18mV/C)	

Construction

- | | | | |
|-----------|--------------------------------|--------------|----------------|
| Component | Raw material | Sealant | Epoxy Resin |
| Positive | Lead dioxide | Safety Valve | EPDR |
| Negative | Lead | Terminal | Copper |
| Container | ABS (Flame Retardent optional) | Separator | Fibre Glass |
| Cover | ABS (Flame Retardent optional) | Electrolyte | Sulphuric acid |

Sealed and maintenance free option

Non-spillable construction design

Ukai
s.a.
<http://www.ukai.com>

UKAI BILBAO
Ribera Elorrieta 7C
48015 Bilbao
Teléfono: 94 474 5252
Fax: 94 475 9710
e-mail: ukai@ukai.com

UKAI BARCELONA
Avda. Vallcarca 74-76
08023 Barcelona
Teléfono: 93 284 0898
Fax: 93 210 6765
e-mail: ukaibcn@ukai.com

UKAI MADRID
Avda Andalucía 2, 2ª planta local 211
28700 San Sebastián de los Reyes
Teléfono: 91 659 0328
Fax: 91 659 0558
e-mail: ukaimad@ukai.com

UL 7 - 12

12V 7AH

STANDBY

Utracell®

'Quality in Every Language'

Charge Characteristic

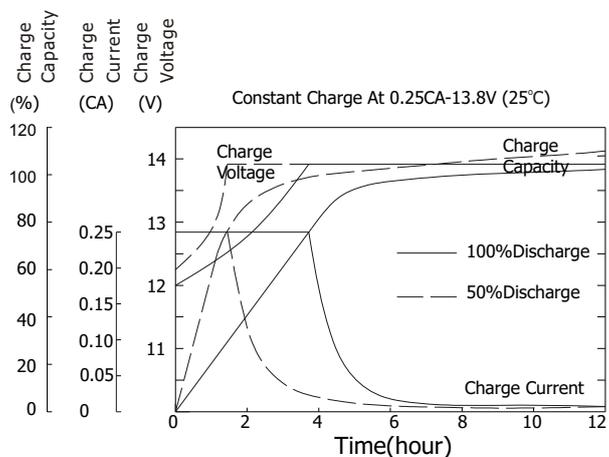

Discharge Characteristic 25°C

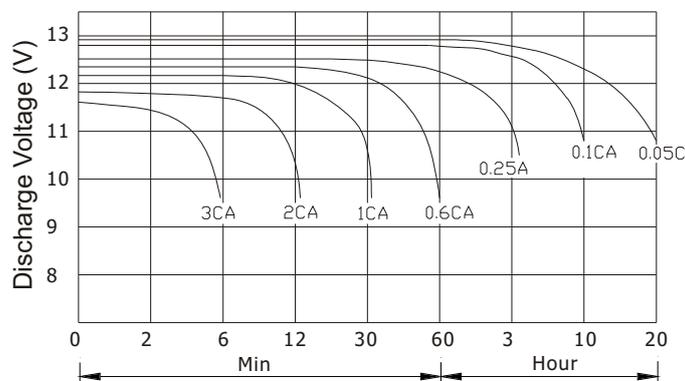

Relationship of OCV and state of charge

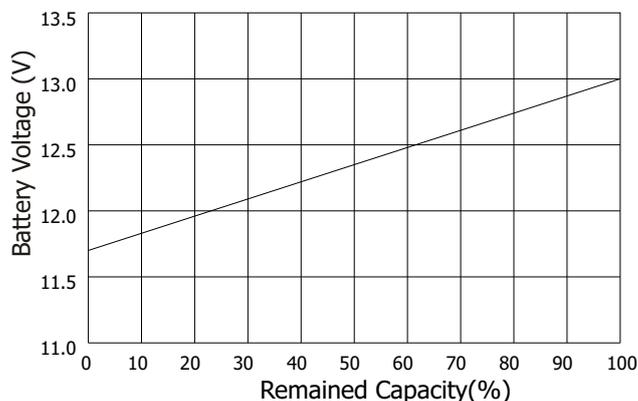

Self Discharge Characteristics

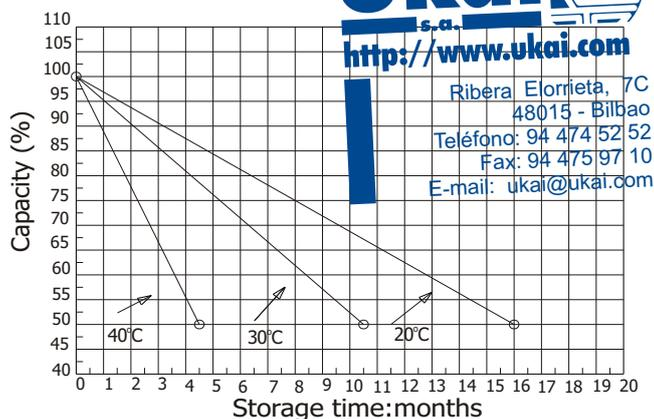

Constant Current Discharge Ratings - amperes at 25°C

F.V / Time	5 MIN	10 MIN	15 MIN	30 MIN	1 HR	3 HR	5 HR	10 HR	20 HR
1.60 V	27.6	16.9	12.8	7.83	4.20	2.18	1.29	0.71	0.39
1.67 V	25.6	16.2	12.4	7.50	4.16	1.85	1.26	0.70	0.37
1.70 V	23.7	15.5	12.0	6.80	4.00	1.75	1.23	0.67	0.36
1.75 V	23.4	15.1	11.7	6.48	3.92	1.70	1.19	0.67	0.35
1.80 V	20.7	14.4	10.6	6.00	3.65	1.67	1.18	0.67	0.35
1.85 V	18.3	13.7	9.49	5.50	3.54	1.64	1.18	0.52	0.35

Constant Power Discharge Ratings - watts at 25°C

F.V / Time	5 MIN	10 MIN	15 MIN	30 MIN	1 HR	3 HR	5 HR	10 HR	20 HR
1.60 V	56.0	36.4	28.0	16.2	9.10	3.54	2.41	1.36	0.71
1.67 V	54.2	35.6	27.6	16.0	9.00	3.53	2.40	1.36	0.71
1.70 V	51.9	35.0	26.9	15.7	8.90	3.50	2.39	1.35	0.70
1.75 V	48.9	33.6	26.0	15.3	8.77	3.47	2.38	1.34	0.70
1.80 V	42.4	31.1	24.9	14.8	8.48	3.42	2.35	1.33	0.69
1.85 V	40.0	28.8	23.8	14.1	8.29	3.36	2.32	1.33	0.69



UKAI BILBAO
 Ribera Elorrieta 7C
 48015 Bilbao
 Teléfono: 94 474 5252
 Fax: 94 475 9710
 e-mail: ukai@ukai.com

UKAI BARCELONA
 Avda. Vallcarca 74-76
 08023 Barcelona
 Teléfono: 93 284 0898
 Fax: 93 210 6765
 e-mail: ukaibcn@ukai.com

UKAI MADRID
 Avda Andalucía 2, 2ª planta local 211
 28700 San Sebastián de los Reyes
 Teléfono: 91 659 0328
 Fax: 91 659 0558
 e-mail: ukaimad@ukai.com