

Led Strips Professional Series

DECCOR-2835-BX-(W)X

Special white color temperature
adjustable LED strip SMD2835 60 led/m



Features

New PCB with ADF Technology, 50% thicker than previous one to improve cooling rating.

Constant current design that extends its useful life.

High Performance LM80 certified 2835 LEDs.

Cutting by groups to facilitate use.

Uniform brightness throughout entire length.

24VDC power supply to get better reliability

Highest performance original 3M VHB back adhesive tape.

International certificates available.

LED strips with special white color temperatures according to the phosphor diffusion treatment.

* LM80 CERTIFIED:
LED LIFESPAN tested under LM80;
Expected LIFETIME of 30,000h.



DECCOR-2835-BX-(W)X

Professional series

SMD2835 dimmable strip



60
Lcd/m

12
W/m

24V

5
Year
Warranty up to

≤930
lm/m

LED SMD
2835

MacAdam
5 level
SDCM
BIN1

CRI
>97
modified

SPECIAL PHOSPHOR
DIFFUSED

1600k

2100k

3600k

25000k

1900k

10
Max. meters in series
(one side powered)

VHB
3M

driver
NOT
included

120°

5m

16,66mm

10cm

30.000 h

20
Max. meters in series
(two side powered)

ADF
PCB

Do not bend

ESD

Dimmable

Alu profile
required

Working
50°C
-20°C

Storage
60°C
-40°C

Features

Part number	CCT / wavelength	Luminous intensity per m / flux	Efficiency lm / W	Energy efficiency	Ordinary strip	Strip with waterproof part number "W" suffix
DECCOR-2835-B1-(W)X	±1600k	±475lm	±40	G	<div style="display: flex; justify-content: space-around;"> <div style="text-align: center;"> 5000mm 1,25mm 10mm </div> <div style="text-align: center;"> 5000mm 4mm 12mm </div> </div> <p>No color temperature deviation.</p>	
DECCOR-2835-B2-(W)X	±2100k	±588lm	±49	G		
DECCOR-2835-B3-(W)X	±3600k	±930lm	±78	G		
DECCOR-2835-B4-(W)X	±25000k	±266lm	±22	G		
DECCOR-2835-B5-(W)X	±1900k	±208lm	±17	G		

Notes

Waterproof led strips covered by silicone material use to suffer an unavoidable CCT value modification owing to optical effect caused when light beam passes through material.
 Initial CCT values are increased several hundreds or thousands of °K. This increasing is much higher in coldest white CCTs.
 New FULLWAT molded silicone system avoids this effect and our waterproof led strips are CCT rated at original value without modification.
 Please, contact with your local sales office to get wider details.

Specific parameters

Reference	Waterproof materials	Size (mm)	Angles	Connections	Mode of fixation	IP grade	Working temperature
DECCOR-2835-BX-X	Non waterproof	10x1,25	120°	Silicone wire Red and white	Adhesive 3M VHB	IP20	-10°C~40°C
DECCOR-2835-BX-WX	extruded tube of sylicon	12x4,0	120°	Silicone wire Red and white	Adhesive 3M VHB	IP67	-10°C~40°C

Curve Line

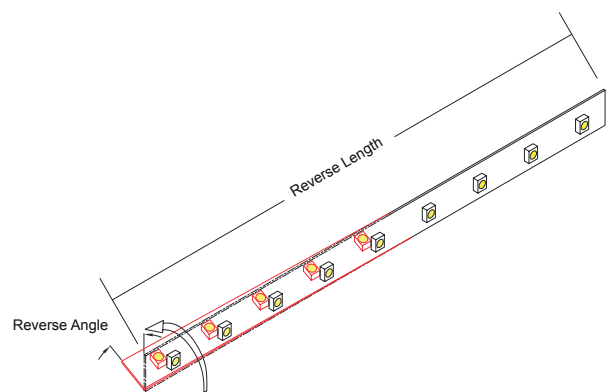
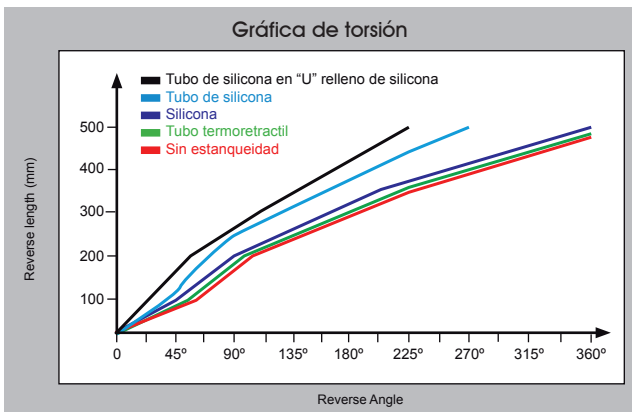
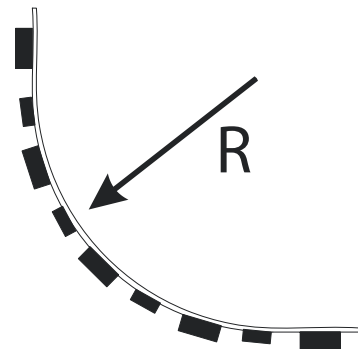
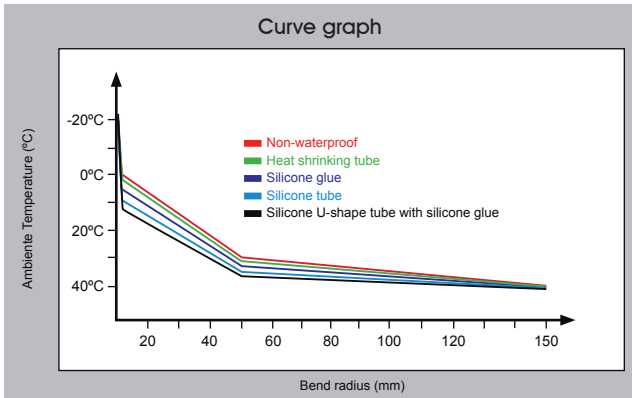

For reference, parameter in tje diagram is tested with 0°Celsius temperature.

WATERPROOF MODEL

Features

- The strip is protected by silicone tube IP67.
- High temperature resistance high flexibility, anti UV, high light transmittance ($\geq 92\%$), non-toxic.
- New sealing system with extruded silicone that prevents changes to the original CCT value (color temperature). Easier handling of connections and welds between different sections.



Accessories



Operation Specification

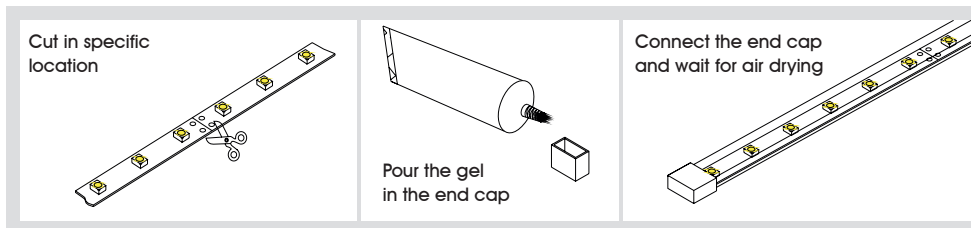

Product size

Front view

Units: mm

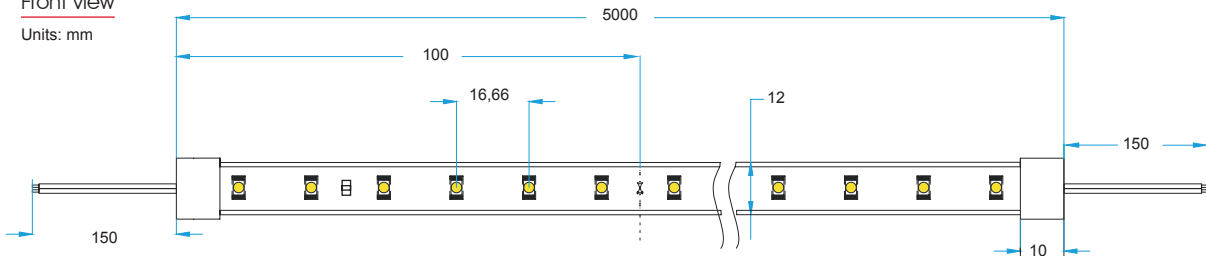

Side view

Units: mm

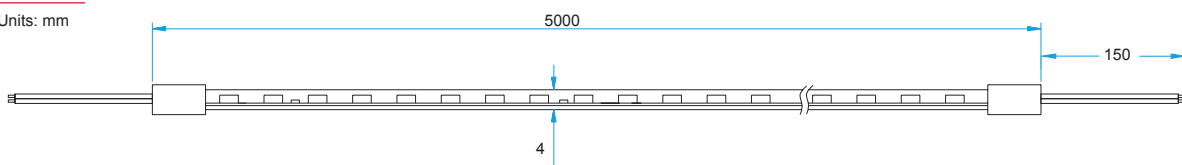

NON WATERPROOF MODEL

Features

- With 3M VHB adhesive tape, it is easy for installation, IP20.
- Small in size, light in weight, flexible..



Optional accessories

ACC8-JOIN-600

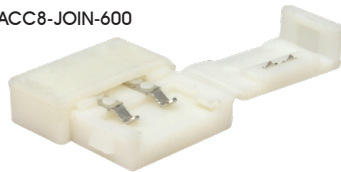

ACC8-CABLE-600

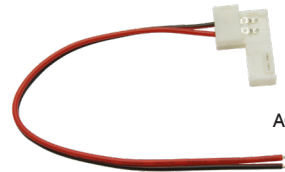

Handing

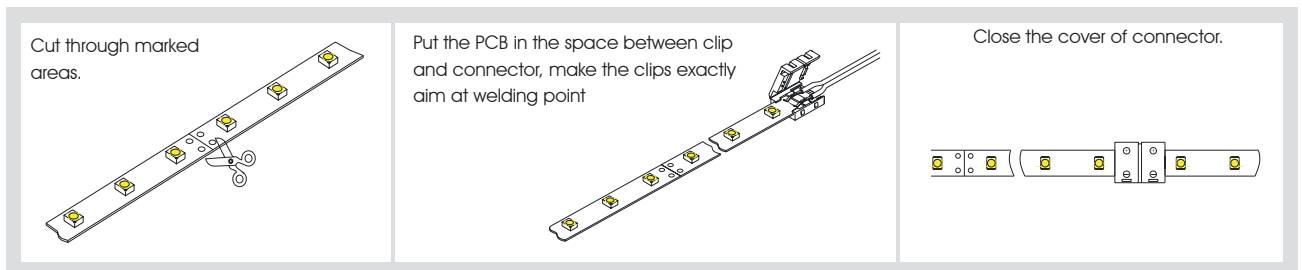

Product size

Frontal view

Units: mm

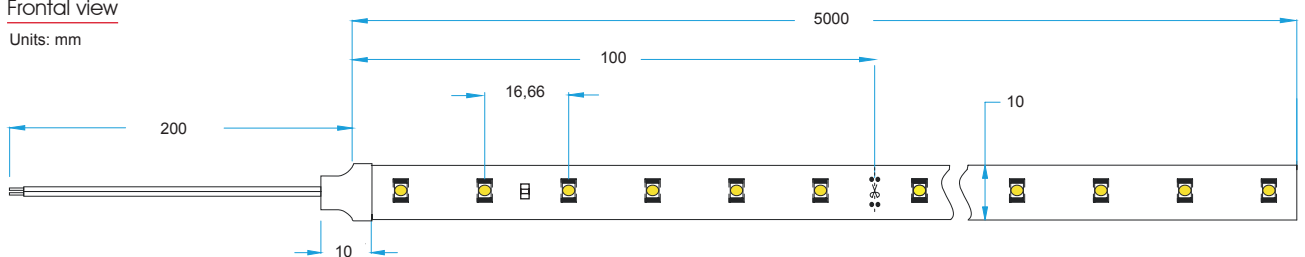

Side view

Units: mm



CONNECTION DIAGRAMS

Non dimmable option

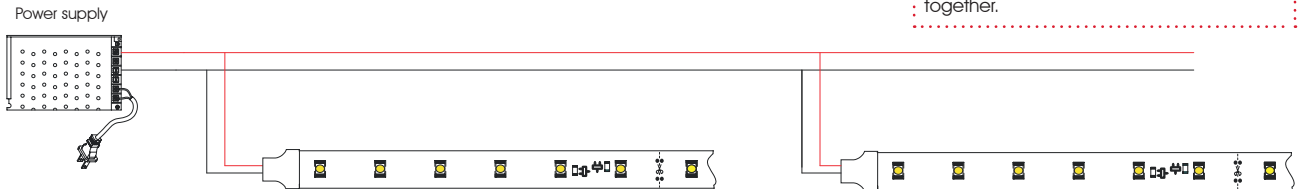

Note:
To ensure the correct operation of the control system, it is recommended that negatives from all power supplies are connected together.

Dimmable option

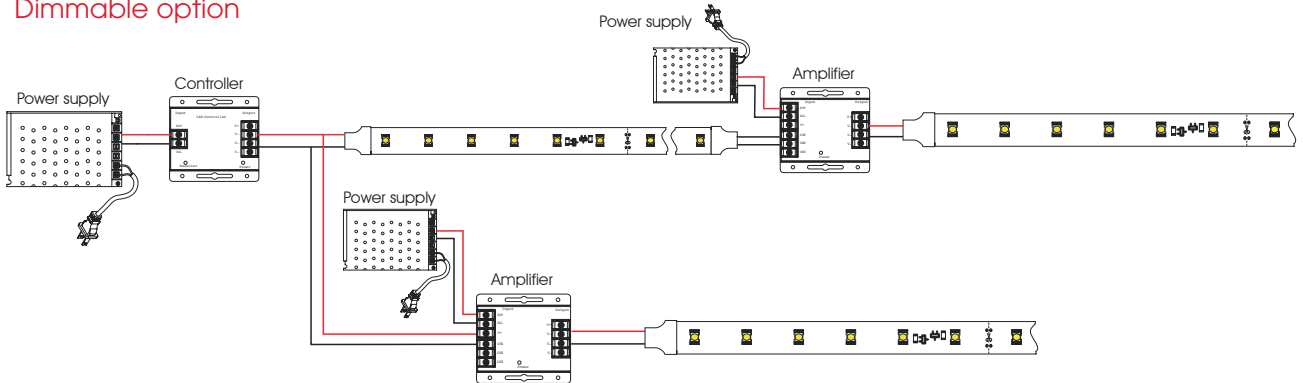

INSTALLATION

Adhesive 3M VHB

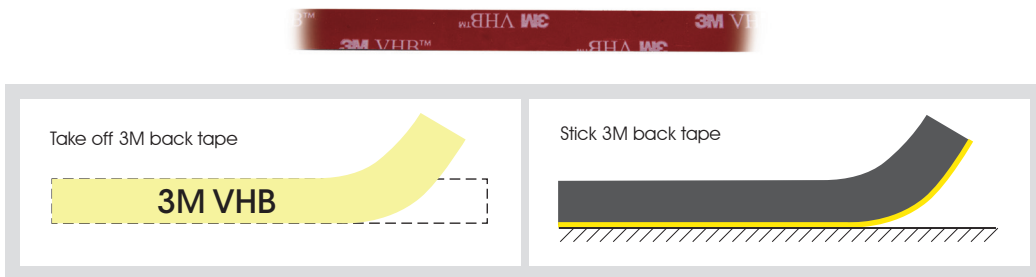

PACKAGING

