

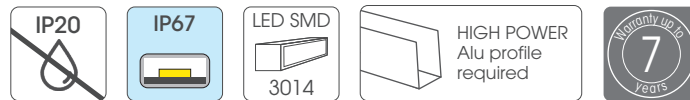

Professional series led strips

FU-BLF-3014L-BX-001(W)X

Dimmable strip with 60 SMD3014 side view LEDs per meter



Features

New PCB with ADF Technology, 50% thicker than previous one to improve cooling rating.

High brightness SMD side view 3014 LEDs compliant with "LM80"*.

Cutting by groups to facilitate use.

Uniform brightness throughout entire length.

24VDC power supply to get better reliability

"SDCM 5" Selection of MacAdam "step5".

Highest performance original 3M VHB back adhesive tape.

Standard color reproduction "CRI>80".

Optional color reproduction "CRI>90".

International certifications available.

* LM80 CERTIFIED:
LED LIFESPAN tested under LM80;
Expected LIFETIME of 30,000h.

FU-BLF-3014L-XX-001(W)X

Professional series

Dimmable strip of 60 SMD3014 leds per meter

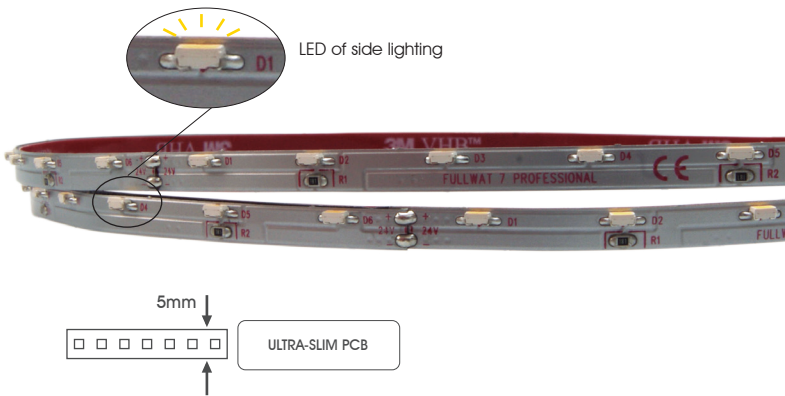

- 60**
Led/m
- 7**
W/m
- 24V**
- Max. only up to
7
years
- ≤720**
lm/m
- LED SMD
3014
- SIDE VIEW
- MacAdam
5 level
SDCM
BIN1
- standard
CRI
>80
- optional
CRI
>90

White color temperature range

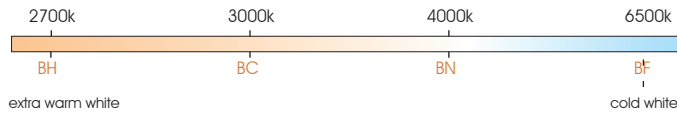

- 10 Max. meters in series (one side powered)
- VHB 3M
- driver NOT included
- 120°
- 5m
- 16,6mm
- 10cm
- 30.000 h
- 20 Max. meters in series (two side powered)
- ADF PCB
- No doblar
- ESD
- Dimmable
- HIGH POWER Alu profile required
- Working 50°C -20°C
- Storage 60°C -40°C

Features

Part number	CCT / wavelength	Luminous intensity per m / flux	Efficiency lm / W	Energy efficiency	Ordinary strip	Strip with waterproof part number "W" suffix
FU-BLF-3014L-BH-001(W)X	±2650~2850k	±600lm	±86	F		
FU-BLF-3014L-BC-001(W)X	±2900~3150k	±600lm	±86	F		
FU-BLF-3014L-BN-001(W)X	±3800~4200k	±660lm	±94	F		
FU-BLF-3014L-BF-001(W)X	±6200~6700k	±720lm	±103	E		No color temperature deviation.

Notes

Waterproof led strips covered by silicone material use to suffer an unavoidable CCT value modification owing to optical effect caused when light beam passes through material. Initial CCT values are increased several hundreds or thousands of °K. This increasing is much higher in coldest white CCTs. New FULLWAT molded silicone system avoids this effect and our waterproof led strips are CCT rated at original value without modification. Please, contact with your local sales office to get wider details.

- 25m
25 length models are available.
- 50m
50 length models are available under request. Contact to our Sales Department.

Specific parameters

Reference	Waterproof materials	Size (mm)	Connections	Fixing mode	IP rate
FU-BLF-3014L-BF-001X	Non waterproof	5x1.25mm	Silicone wire red and white	Adhesive 3M VHB	IP20
FU-BLF-3014L-BF-001WX	Silicone extruded tube	7x4mm	5.5mm DC connector	Adhesive 3M VHB	IP67

Bending grades

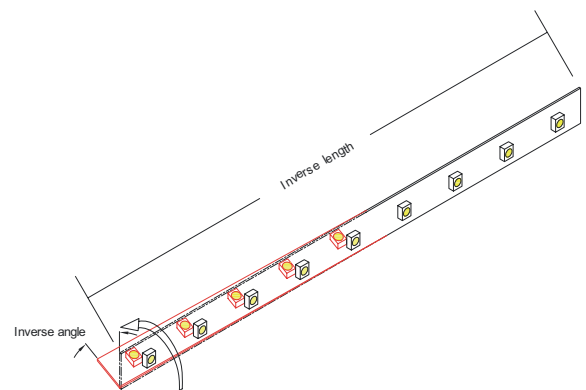
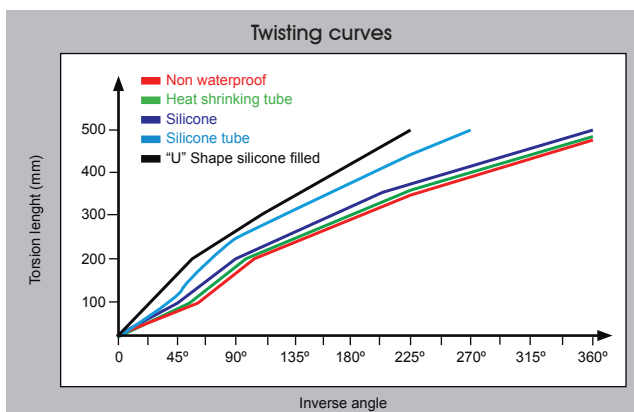
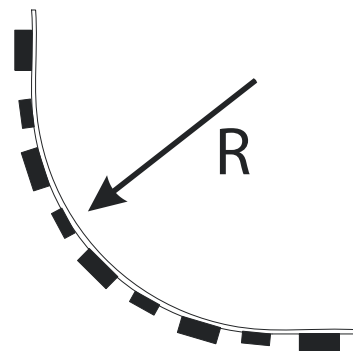
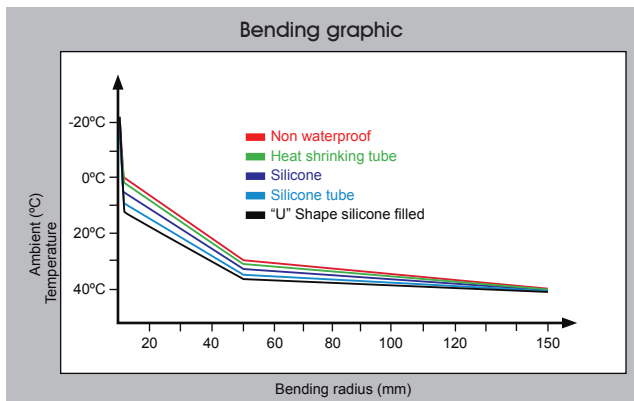

Reference point: strip bending at 0°C.

NON WATERPROOF MODEL

Features

- IP20 easier assembling 3M VHB.
- Small size, light weight, flexible.



Handing

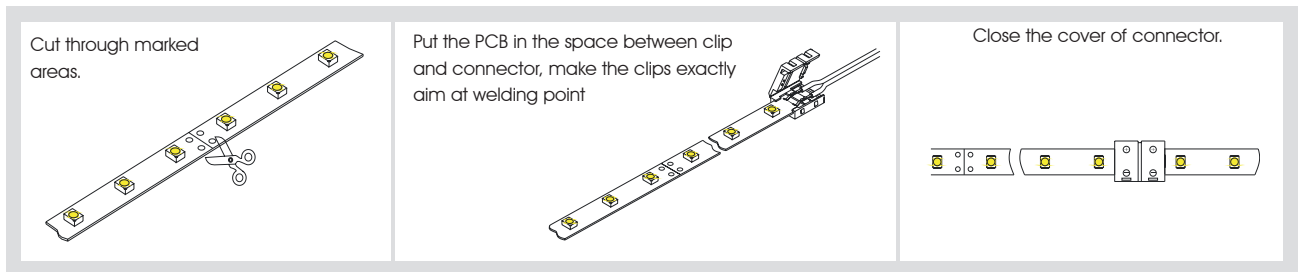

Product size

Frontal view

Units: mm

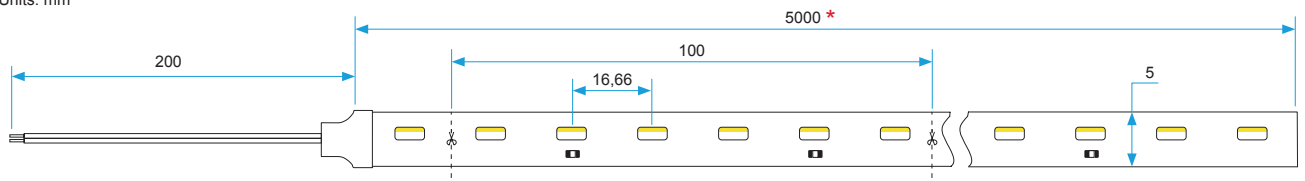

Side view

Units: mm



* 25m length models available references: FU-BLF-3014L-BX-001X/25.
50m length models available references: FU-BLF-3014L-BX-001X/50.

■ WATERPROOF MODEL

Features

- IP67 Rating with high performance molded silicone.
- High temperature, maximum flexibility, anti-UV, non toxic and improved optical transmittance >92%
- **New waterproof molded** silicone system to avoid CCT (color temperature) value modifications. Improved soldering pads in every cutting areas.

Optional accesories



FU-BLF-CON-SEALED
Male-female DC conectors

Handling

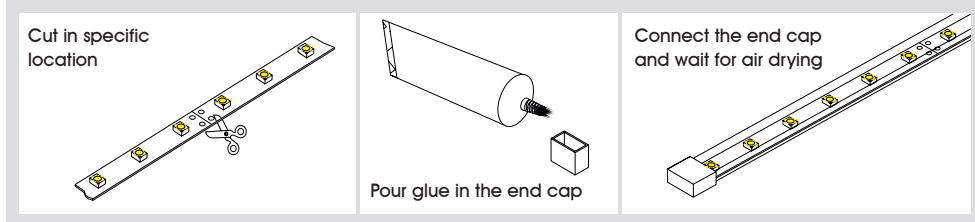

Product size

Front view

Units: mm

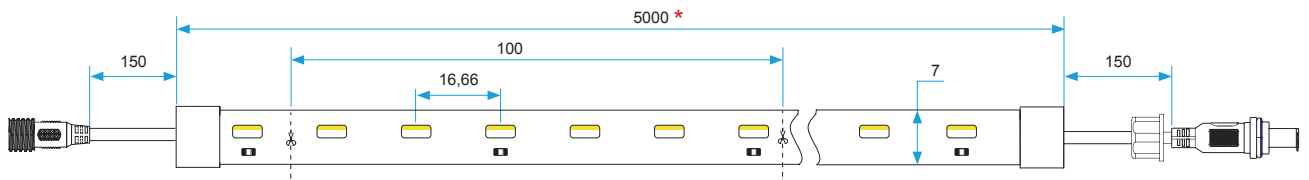

Side view

Units: mm



* 25m length models available references: FU-BLF-3014L-BX-001WX/25.
50m length models available references: FU-BLF-3014L-BX-001WX/50.

CONNECTION DIAGRAMS

Non dimmable option

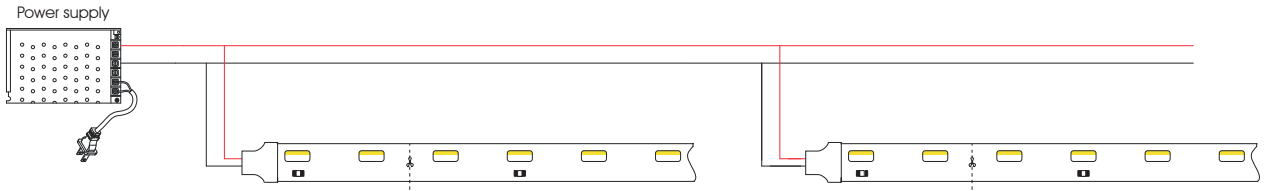

Dimmable option

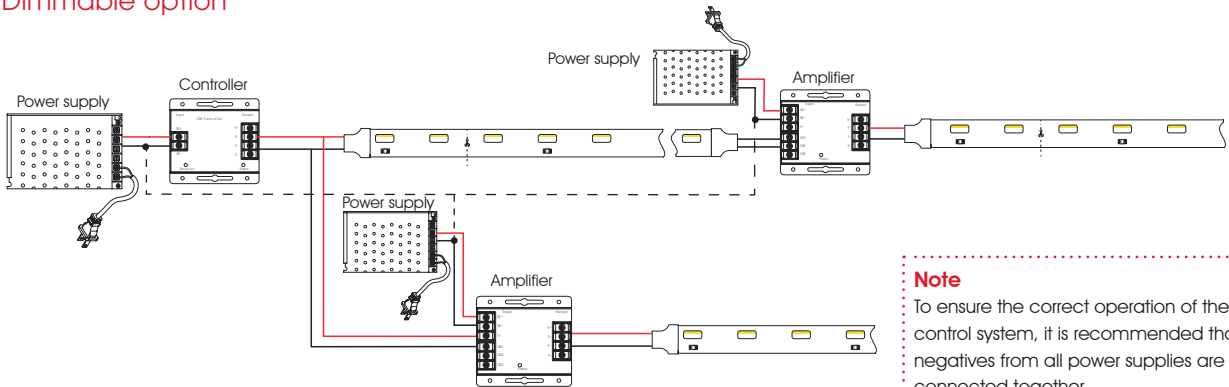

Note
To ensure the correct operation of the control system, it is recommended that negatives from all power supplies are connected together.

INSTALLATION

Adhesive 3M VHB

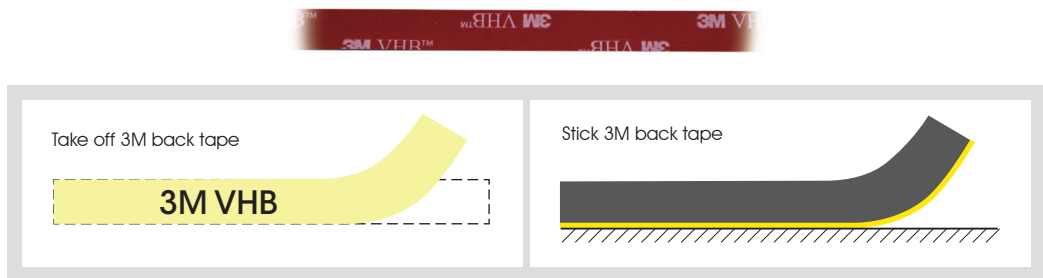

PACKAGING

