

# side view neon NL-1010HL-BX



Flame Protected



Resistant to solvents



Saltwater resistant



UV resistant



IP67 Immersion Protection



LK08 protection



Beam angle 120°



Min. bending diameter Ø100mm



Free cutting

## BRIEF PARAMETERS

Forward Voltage:	24VDC
Power:	<10W/m
Led color:	White
Wave length:	2700-4000K
Width:	10mm
Thickness:	10mm
Min. Bending diameter	≥100mm
IP grade	IP67 / IP65 (Depending on the connectors used: factory or mounted)

**SIDE VIEW**  
Horizontal Bending  
Horizontal bending against  
the light surface

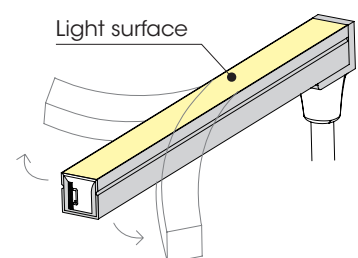
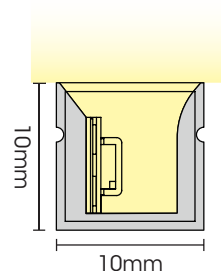

### PRODUCT FEATURES

- **Freely cutting Neon flex, greater flexibility to customized length.**
- Led strip inside: 160led/m SMD2835.
- Finished product: SDCM<3, better color consistency.
- Dimension: 10x10mm.
- Special design, still works however inner FPC board damaged in one or more pieces.
- With matte treatment, smooth surface and resistant to dust.
- Same width end cap as the strip.
- Power cord with 3 directions: Straight powered, side powered, back powered.
- Constant voltage design, Max.run (single end feed): 10m/pcs, freely cutting with the fast connectors.

### OPTICAL PARAMETER

Item	Color/CCT	Lumen/m	Power/m	Voltage	Light efficiency	CRI (Ra)	Max. Run (single end feed)	Minimum section	Color tolerance
NL-1010HL-BH	2700K	410Lm	<10W	24VDC	41Lm/W	90+	10m	Freely cutting	SDCM<3
NL-1010HL-BC	3000K	435Lm	<10W	24VDC	43Lm/W	90+	10m	Freely cutting	SDCM<3
NL-1010HL-BCN*	3500K	460Lm	<10W	24VDC	46Lm/W	90+	10m	Freely cutting	SDCM<3
NL-1010HL-BN	4000K	490Lm	<10W	24VDC	49Lm/W	90+	10m	Freely cutting	SDCM<3

\* Available under request.

### LUMINOUS INTENSITY DISTRIBUTION DIAGRAM

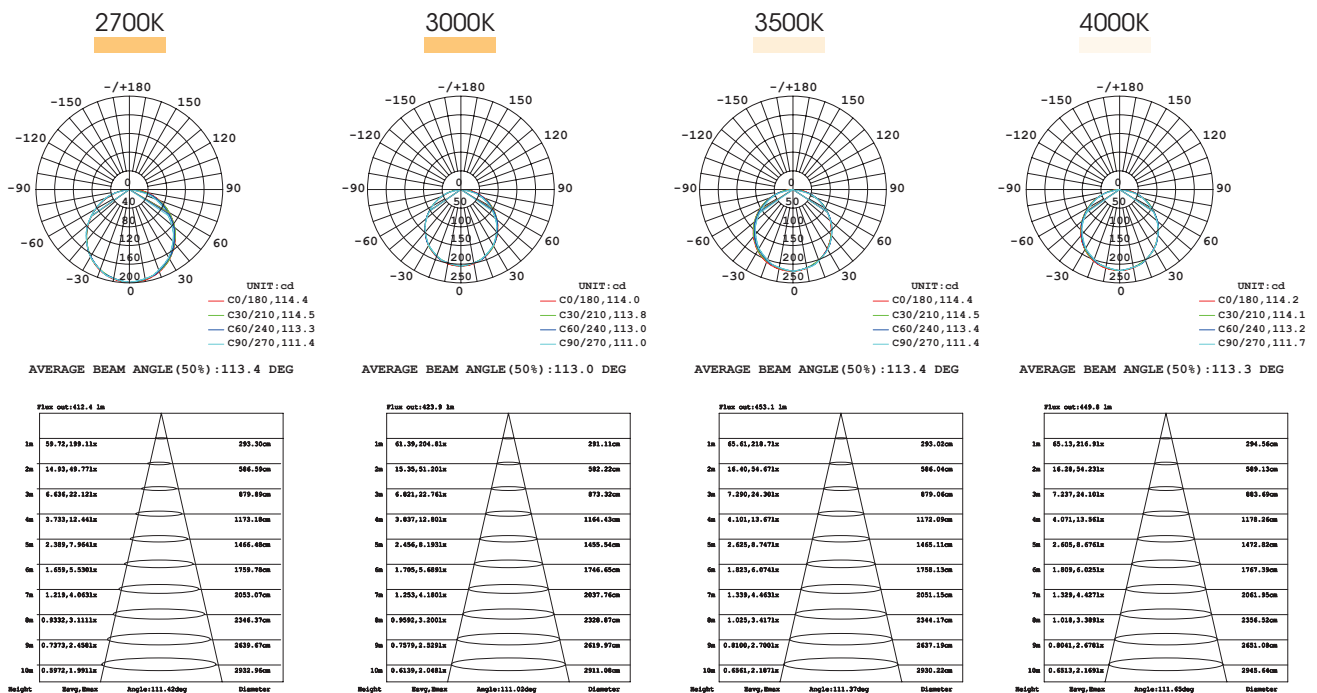

**DIMENSIONS AND OUTLET DIRECTION**  
Unit:mm

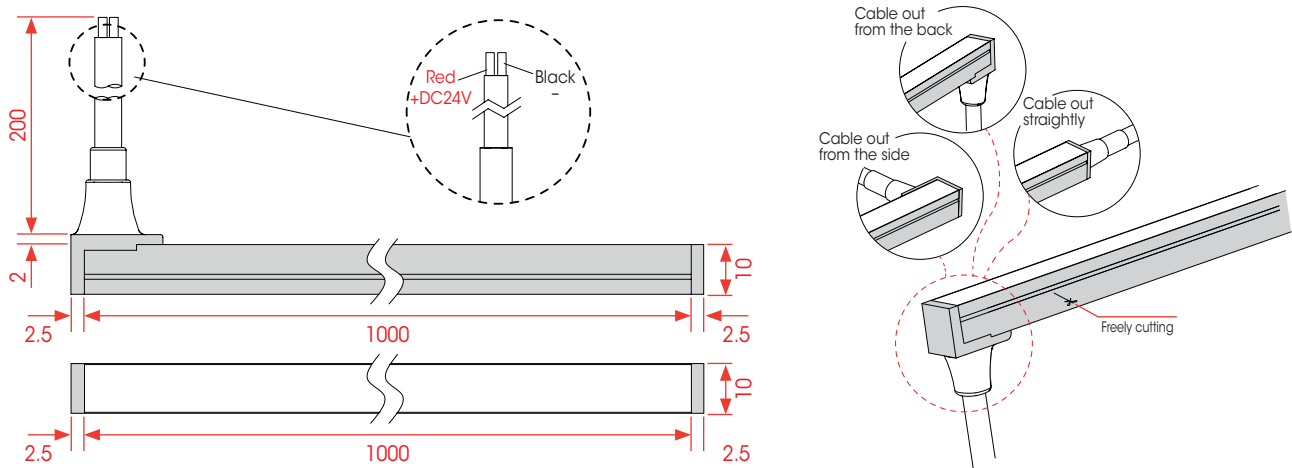

**Notice:** End cap with the same width as the tape light.

**CONNECTING ACCESSORIES**  
(IP65)

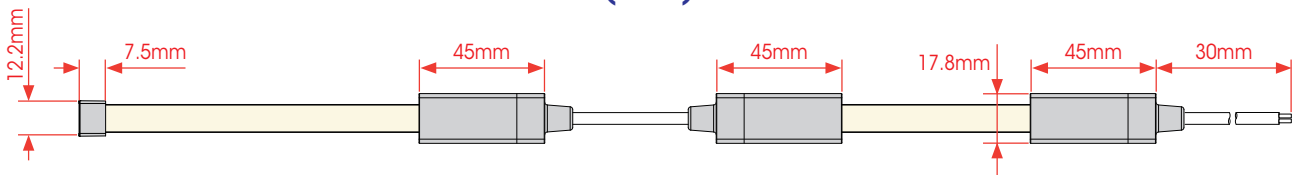

END CAP (IP65, with silicon glue)



JUMPER CONNECTOR-STRAIGHT

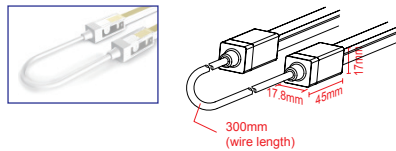

END-STRAIGHT

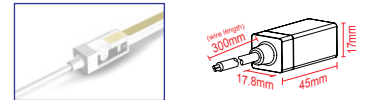

END CAP (IP65, without glue)

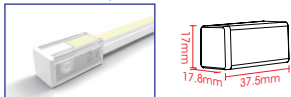

END-SIDE LEFT



END-SIDE RIGHT



END-BOTTOM

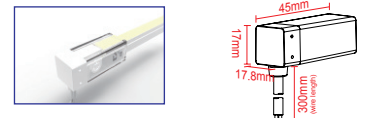

## INSTALLATION ACCESORIES

Aluminium Buckle  
12x12.5x25mm

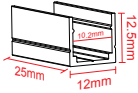

Screw  
15x3.5mm

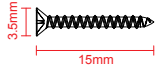

Lenght	1000mm
Buckle	4pcs
Screw	4pcs

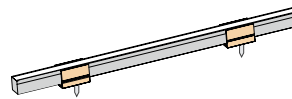

Aluminium profile  
12x12.5x2440mm

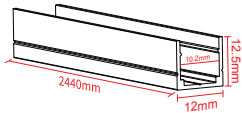

Screw  
15x3.5mm

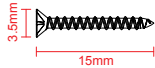

Lenght	2440mm
Screw	10pcs

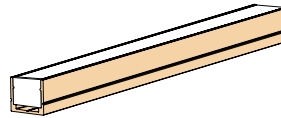

## PACKAGING

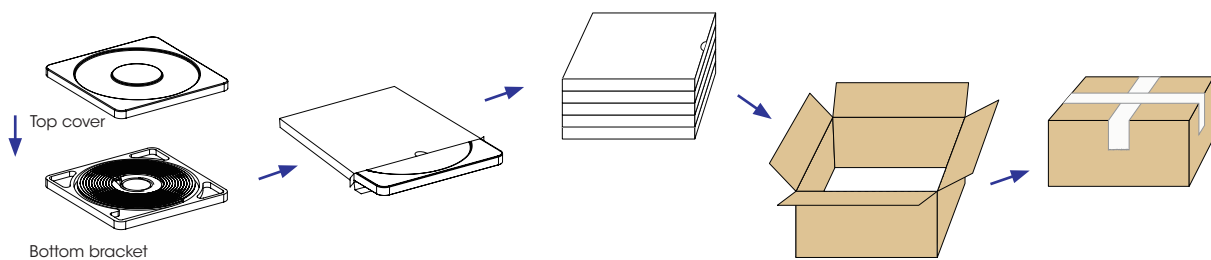

Light length	Plastic box dimension	White box dimension	Numbers of white box	Carton dimension
1m	275x275x30.5mm	275x35x275mm	40pcs	570x570x380mm
5m	385x385x35mm	390x40x390mm	10pcs	410x410x430mm
10m	480x480x35mm	485x40x485mm	5pcs	505x505x230mm

**NEON LED STRIP INSTRUCTION AND CAUTION**

**Light Profile**

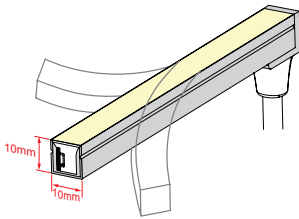

**Correct bending way**

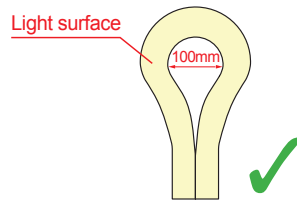

Face to the light surface  
fold the strip, the minimum  
bending diameter is 100mm.

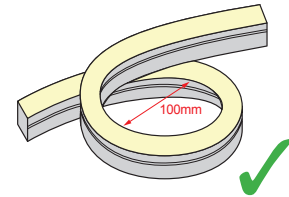

Light surface upwards, the  
strip is bendable to right or  
left naturally, the minimum  
bending diameter is 100mm.

**Bending direction Profile**

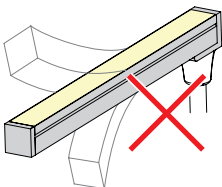
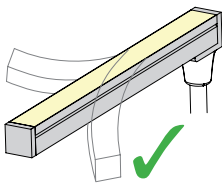

**Incorrect bending way**



Face to the side surface,  
(as the picture shows)  
Do not bend downward to  
damage the strip.

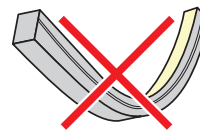

Face to the side surface,  
(as the picture shows)  
Do not bend upward to  
damage the strip.



(as the picture shows)  
please do not twist  
the strip, or it will be  
damaged.