



## Led Strips Professional Series

CCTX-2835-XX-2(W)X

Dimmable LED strip with temperature control  
SMD2835 - 120Leds/meter



### Features

**New PCB with ADF Technology**, 50% thicker than previous one to improve cooling rating.  
Improved circuit desing with constant current and temperature control to get better lifespan.

High Performance LM80 certified 2835 LEDs.

Cutting by groups to facilitate its use.

Uniform brightness throughout entire length.

Constant current design to extend useful life

24VDC power supply to get better reliability

"SDCM 3" MacAdam selection "step3"

Highest performance original 3M VHB back adhesive tape.

CRI>83 standard rate.

CRI>97 optional rate under request.

CE, LVD & EMC European certificates available.

\* LM80 CERTIFIED:  
LED LIFESPAN tested under LM80;  
Expected LIFETIME of 30,000h.

**CCTX-2835-XX-2(W)X**

Professional series



Dimmable LED strip with temperature control

<b>120</b> Led/m	<b>19,2</b> W/m	<b>24V</b>	<b>7</b> Years
<b>≤2600</b> lm/m	<b>≤135</b> lm/w	LED SMD 2835	MacAdam 3 level SDCM BIN1
<b>CRI &gt;83</b> standard	<b>CRI &gt;97</b> optional	CONTROL™	

White color temperature range

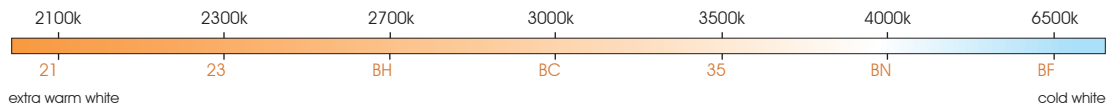

10 Max. meters in series (one side powered)	VHB 3M	driver NOT included	120°	5m	8,33mm	5cm	30.000 h
20 Max. meters in series (two side powered)	ADF-PCB	Do not bend	ESD	Dimmable	HIGH POWER Alu profile required	Working 50°C -20°C	Storage 60°C -40°C

**Features**

Part number	CCT / wavelength	Luminous intensity per m / flux	Efficiency lm / W	Energy efficiency	Ordinary strip	Strip with waterproof part number "W" suffix
CCTX-2835-21-2(W)X	±2050~2150k	±2175lm	±113	E	 5000mm 1,25mm 10mm	 5000mm 4mm 12mm  No color temperature deviation.
CCTX-2835-23-2(W)X	±2250~2350k	±2230lm	±116	E		
CCTX-2835-BH-2(W)X	±2700~2800k	±2295lm	±120	E		
CCTX-2835-BC-2(W)X	±2950~3100k	±2350lm	±122	E		
CCTX-2835-35-2(W)X	±3400~3500k	±2400lm	±125	D		
CCTX-2835-BN-2(W)X	±3900~4050k	±2475lm	±129	D		
CCTX-2835-BF-2(W)X	±6400~6600k	±2600lm	±135	D		

**Notes**

Waterproof led strips covered by silicone material use to suffer an unavoidable CCT value modification owing to optical effect caused when light beam passes silicone material.  
Initial CCT values are increased several hundreds or thousands of °K. This increasing is much higher in coldest white CCTs. New FULLWAT molded silicone system avoids this effect and our waterproof led strips are CCT rated at original value without modification.  
Luminances in the case of CR197 LED strips are reduced by about 10% compared to the values declared for CR183 LED strips. Please, contact with your local sales office to get wider details.

**25m**  
25 length models are available.

**50m**  
50 length models are available under request. Contact to our Sales Department.

Specific parameters

Reference	Waterproof materials	Size (mm)	Connections	Mode of fixation	IP rate
CCTX-2835-BF-2X	Non waterproof	10x1.25	Silicone wire red and white	Adhesive 3M VHB	IP20
CCTX-2835-BF-2WX	Silicone extruded tube	12x4	5.5mm DC connector	Adhesive 3M VHB	IP67

Bending grades

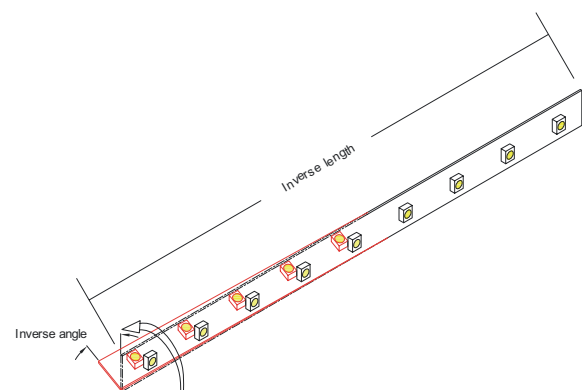
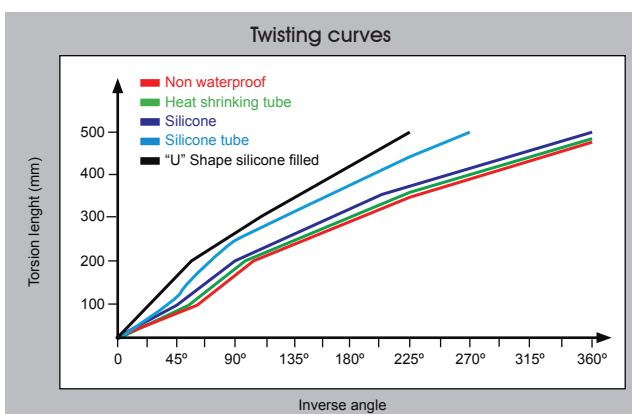
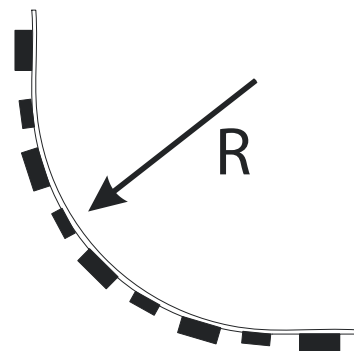
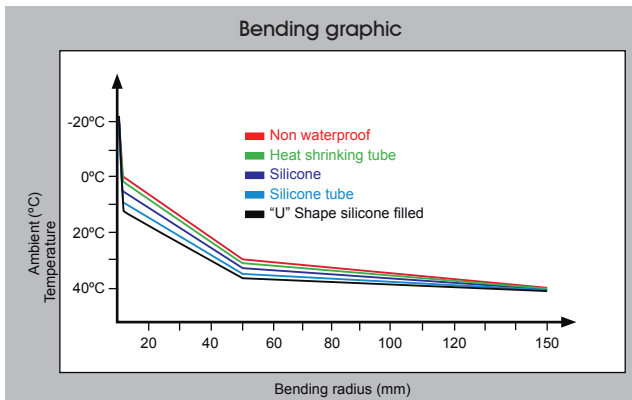

Reference point: strip bending at 0°C.

**NON-WATERPROOF MODEL**

Features

- IP20 easier assembling 3M VHB.
- Small in size, light in weight, flexible.



Optional accesories

ACC10-JOIN-600



ACC10-CABLE-600

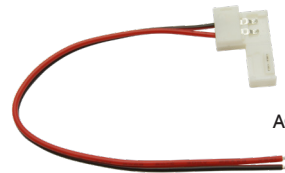

Operation specification

<p>Cut in specific location.</p>	<p>Put th PCB in the space between clip and connector, make the clips exactly aim at welding point.</p>	<p>Close the cover of connector</p>
----------------------------------	---	-------------------------------------

Product size

Front view

Units: mm

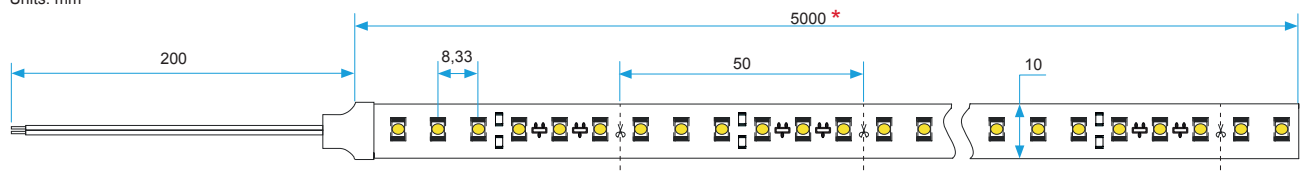

Size view

Units: mm

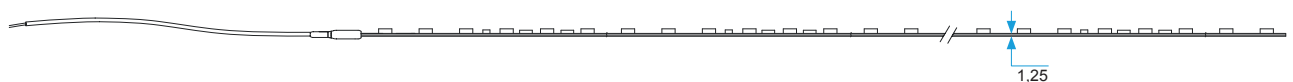

\* 25 length models are available for references CCTX-2835-XX-2X/25.  
50 length models are available for references CCTX-2835-XX-2X/50.

**WATERPROOF MODEL**

**Features**

- IP67 Rating with high performance molded silicone.
- High temperature, maximum flexibility, anti-UV, non toxic and improved optical transmittance >92%
- **New waterproof molded silicone system** to avoid CCT (color temperature) values modifications. Improved soldering pads in every cutting areas.



**Optional accesories**

Silicone caps



ACC10-CAPS-SIDE1

ACC10-CAPS-SIDE2

Male-female DC connectors



FU-BLF-CON-SEALED

Silicone gel tube



FU-BLF-GLUE

**Handling**

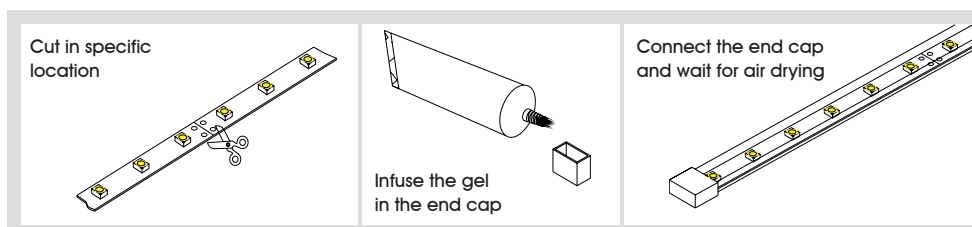

**Product size**

Front view

Units: mm

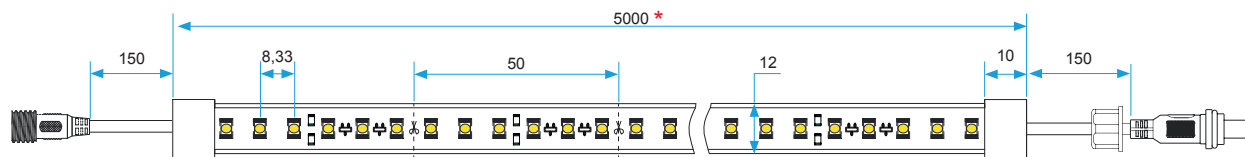

Side view

Units: mm

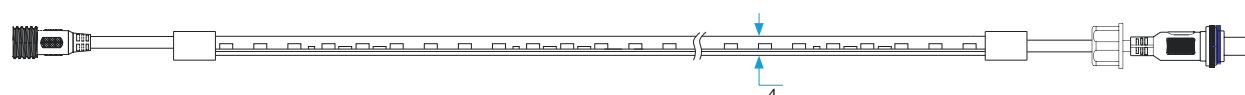

\* 25 length models are available for references CCTX-2835-XX-2WX/25.  
50 length models are available for references CCTX-2835-XX-2WX/50.

**CONNECTION DIAGRAMS**

Non dimmable option

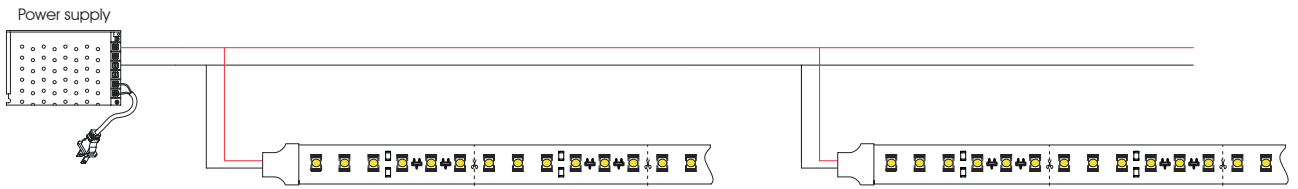

Dimmable option

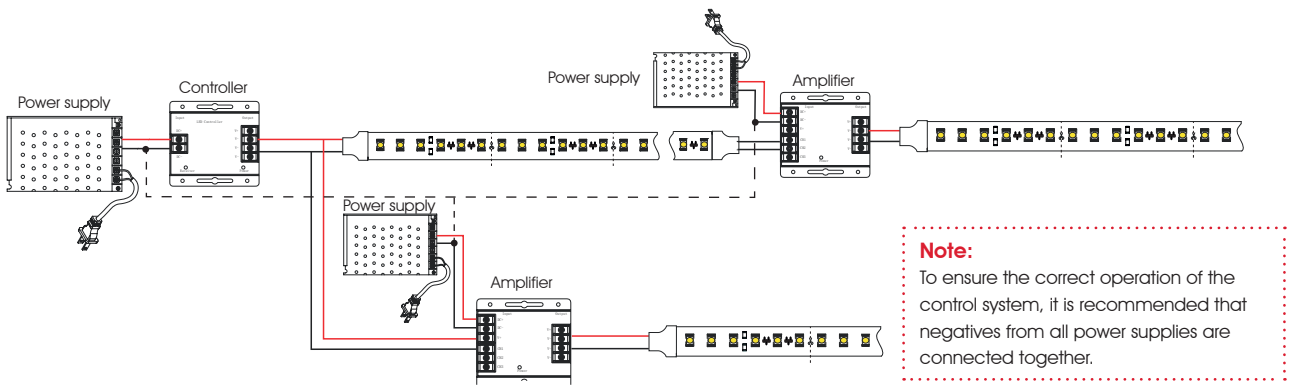

**INSTALLATION**

Adhesive 3M VHB



**PACKAGING**

