



Led Strips Professional Series

FU-BLF-2216-XX-3X

Dimmable LED strip SMD2216 180 LED/m



Features

New PCB with ADF Technology, 50% thicker than previous one to improve cooling rating.

High Performance LM80 certified 2216 type leds

It allows the cutting by groups to facilitate its use.

Uniform brightness throughout its entire length.

24 VDC power supply to get better reliability

"SDCM 3" MacAdam selection "step3"

Highest performance original 3M VHB back adhesive tape.

CRI>83 standard rate

CRI<90 optional rate under request.

CE, LVD & EMC European certificates available.

* LM80 CERTIFIED:
LED LIFESPAN tested under LM80;
Expected LIFETIME of 30,000h.

FU-BLF-2216-XX-3X

Professional series



Dimmable LED strip SMD2216 180 LED/m

- 180**
Led/m
- 14**
W/m
- 24V**
- Warranty up to **7**
Years
- ≤1620**
lm/m
- LED SMD
2216
- MacAdam
3 level
SDCM
BIN1
- standard
CRI
>83
- optional
CRI
>90

White color temperature range

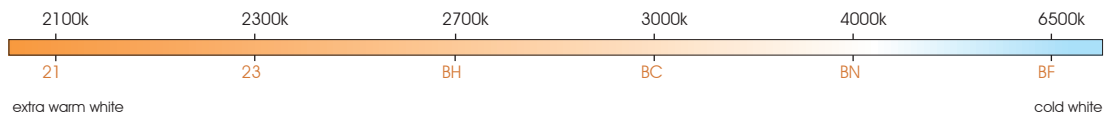

- 5 Max. meters in series (one side powered)
- VHB 3M
- driver NOT included
- 120°
- 5m
- 5,55mm
- 3,33cm
- 30.000 h
- 10 Max. meters in series (two side powered)
- ADF PCB
- Do not blend
- ESD
- Dimmable
- HIGH POWER Alu profile required
- Working 50°C -20°C
- Storage 60°C -40°C

Features

Part number	CCT / wavelength	Luminous intensity per m / flux	Efficiency lm / W	Energy efficiency	Ordinary strip
FU-BLF-2216-21-3X	±2050~2150k	±1080lm	±77	G	
FU-BLF-2216-23-3X	±2250~2350k	±1170lm	±84	F	
FU-BLF-2216-BH-3X	±2700~2800k	±1350lm	±96	F	
FU-BLF-2216-BC-3X	±2950~3100k	±1440lm	±103	E	
FU-BLF-2216-BN-3X	±3900~4100k	±1530lm	±109	E	
FU-BLF-2216-BF-3X	±6400~6600k	±1620lm	±116	E	

Notes

Waterproof led strips covered by silicone material use to suffer an unavoidable CCT value modification owing to optical effect caused when light beam passes through material. Initial CCT values are increased several hundreds or thousands of °K. This increasing is much higher in coldest white CCTs. New FULLWAT molded silicone system avoids this effect and our waterproof led strips are CCT rated at original value without modification. Please, contact with your local sales office to get wider details.

- 25m 25 length models are available.
- 50m 50 length models are available under request. Contact to our Sales Department.

Specific parameters

Reference	Waterproof materials	Size (mm)	Connections	Mode of fixation	IP rate
FU-BLF-2216-BF-3X	Non waterproof	4x1.25	Silicone wire red and white	Adhesive 3M VHB	IP20

Bending grades

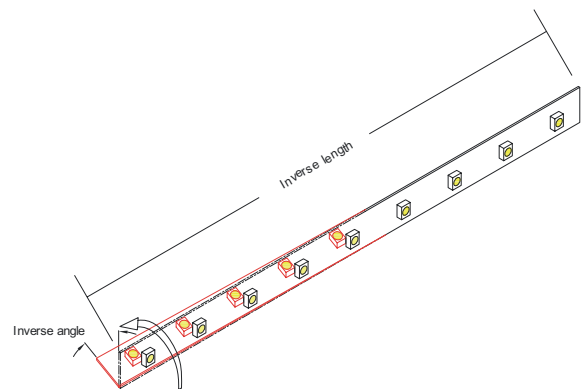
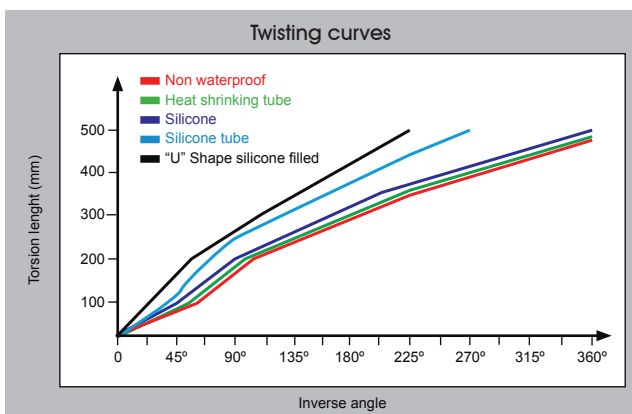
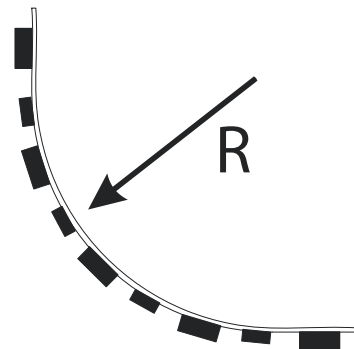
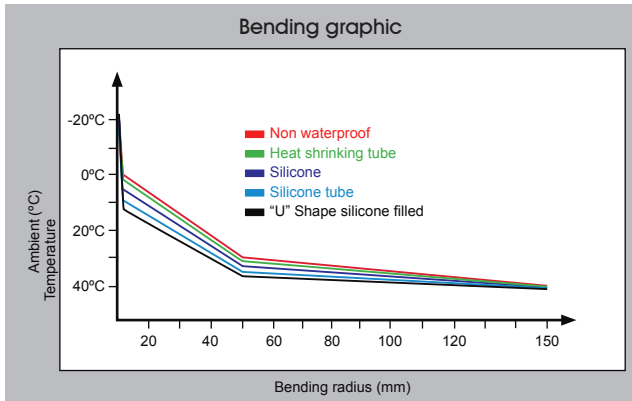

Reference point: strip bending at 0°C.

■ NON-WATERPROOF MODEL

Features

- IP20 easier assembling 3M VHB.
- Small in size, light in weight, flexible.



Operation specification

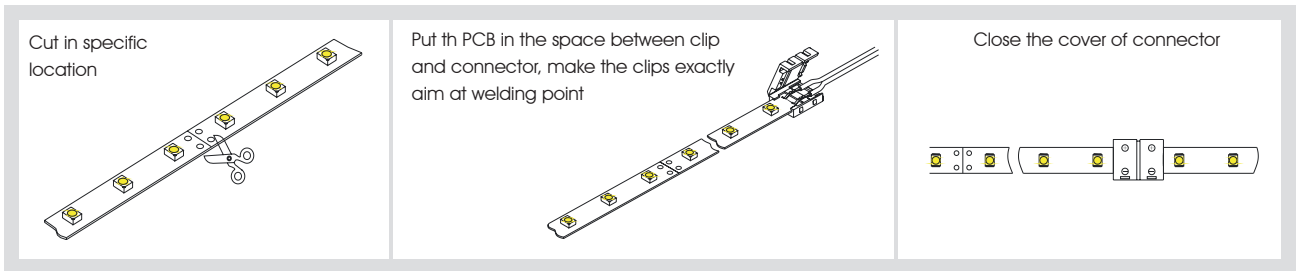

Product size

Front view

Units: mm

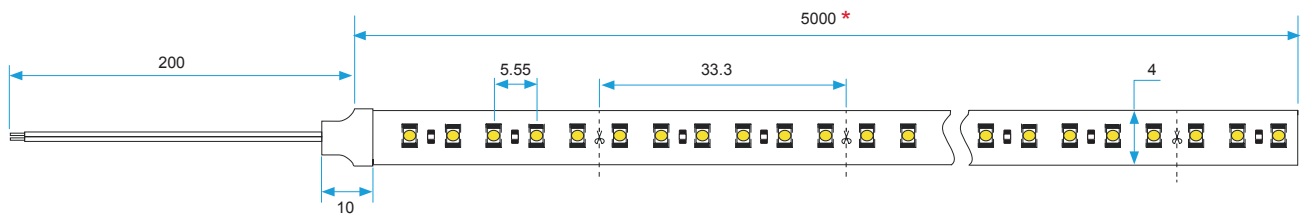

Side view

Units: mm

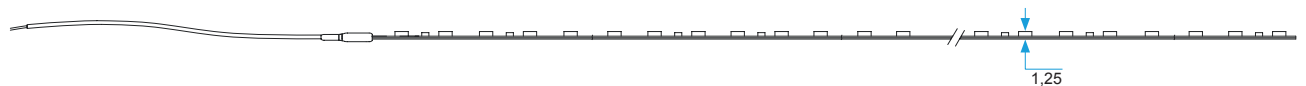

* 25 length models are available for references FU-BLF-2216-XX-3X/25.
50 length models are available for references FU-BLF-2216-XX-3X/50.

CONNECTION DIAGRAMS

Non dimmable option

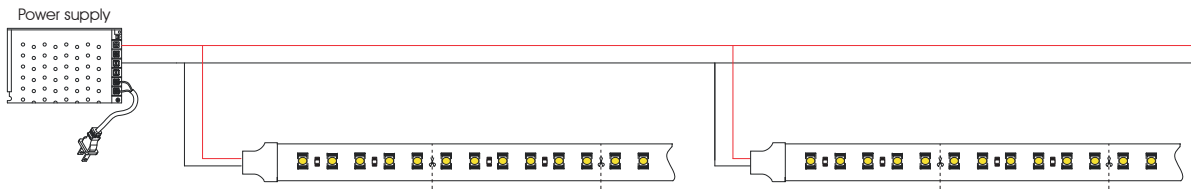

Dimmable option

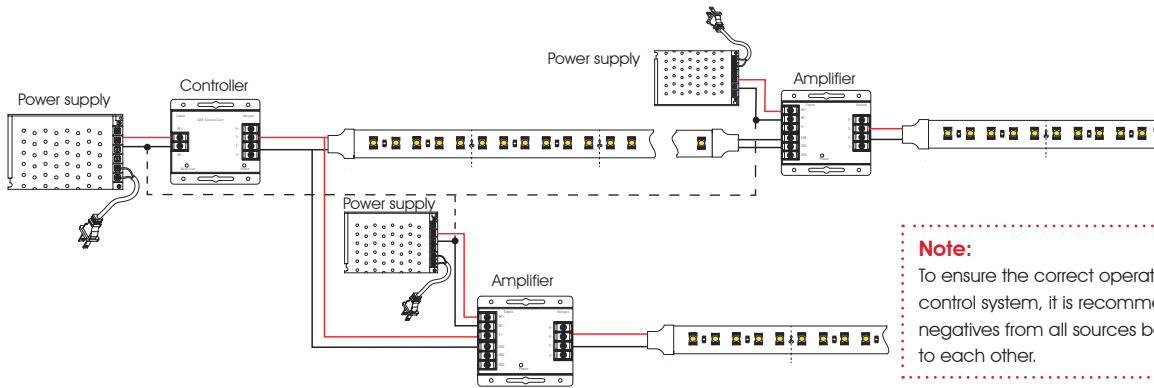

INSTALLATION

Adhesive 3M VHB

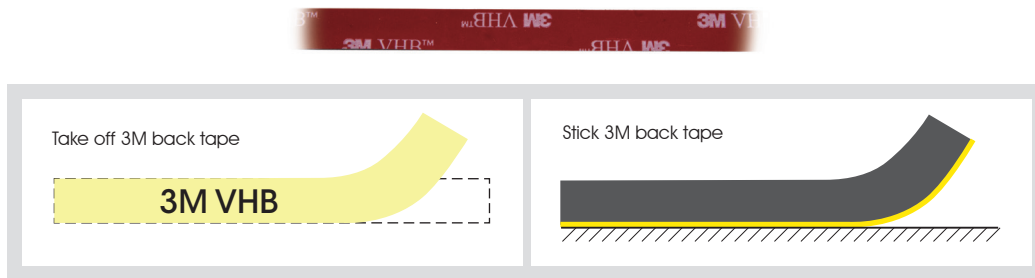

PACKAGING

