



touch panel - 4 ZONES control **LENNY-PAN-B4**



Smart LED control system

New smart LED **color control system** with 2.4GHz remote control.

Auto synchronisation and **auto transmission** functions.

The device adopts low power consumption technologies and one controller can manage several receivers at the same time.

The system does not produce interference as it uses a very low level transmission signal.

Suitable for simple installations in both domestic and professional environments.

Owners manual

LENNY-PAN-B4 4 ZONES control

Smart LED control system

Technical specifications	3
Single color	5
Touch panel functions	
Mobile control	
Tunable white	7
Touch panel functions	
Mobile control	
RGB	9
Touch panel functions	
Mobile control	
RGBW	11
Touch panel functions	
Mobile control	
RGBWW	13
Remote control functions	
Mobile control	
Led Strip-controller connection	15
List of LENNY-DRV-LS2 modes and functions for RGB / RGBW / RGBWW	17
List of LENNY-DRV-WL5 modes and functions for RGB / RGBW / RGBWW	17
System linking and unlinking	18
Device auto-sync	19
Auto-transmitting function	19
Installation diagram	20
Mobile phone pairing	22
Alexa linking	26
Google Home linking	27
Google Assistant linking	28
Compatibility table	29
Table of controls by zones	30

LENNY-PAN-B4 4 ZONES control

Smart LED control system

Technical specifications

Touch panel	
Modelo	LENNY-PAN-B4
Voltaje	3V (2 pilas AAA)*
Potencia de transmisión	6dBm
Consumo de reposo	20uA
Temperatura de trabajo	-10~40°C
Frecuencia de funcionamiento	2.4GHz
Alcance aprox.	30m

* Not included.

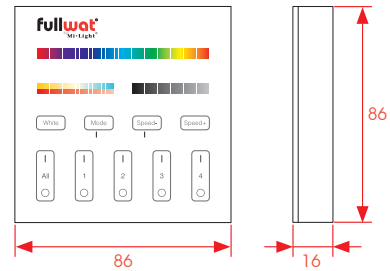

DIRECT CURRENT DRIVERS			
	LENNY-DRV-LS2	LENNY-DRV-WL5	LENNY-DRV-WL2P
Description	5 in 1 receiver	WiFi 5 in 1 receiver	WiFi 2 in 1 receiver
Voltage	DC12V~24V (terminal block & jack plug inputs)		
Output max. current	6A per channel		12A per channel
Total current	15A		12A
Working temperature	-20~60°C		-10~40°C
Working frequency	2.4GHz		
Aprox. operational distance	30m		
Connection mode	Common anode		
WIFI	Requires gateway LENNY-WIFOX1	Included	

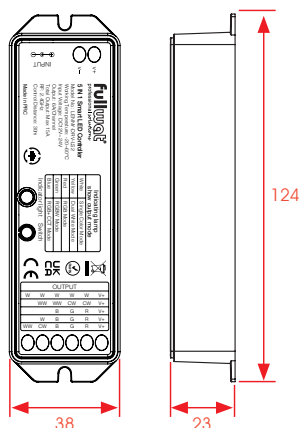

LENNY-DRV-LS2

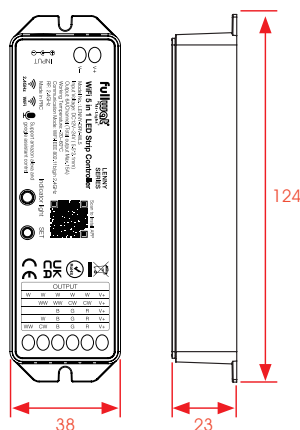

LENNY-DRV-WL5

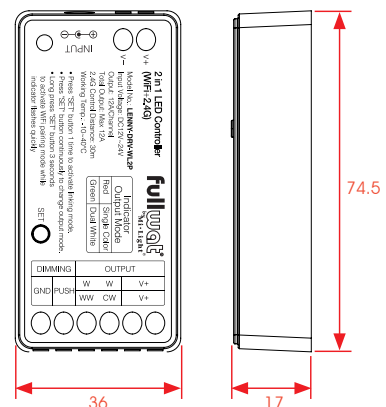

LENNY-DRV-WL2P

LENNY-PAN-B4 4 ZONES control

Smart LED control system

Technical specifications

ALTERNATE CURRENT DRIVER		TRIAC controller
Model	LENNY-TRIAC1	
Input voltage	AC 100-240V 50/60Hz	
Output voltage	AC 100-240V	
Output current	MAX 1.36A	
Output power	150W@100VAC; 300W@240VAC	
Regulation method	Wireless RF, push button, APP	
RF range	30m	
Working temperature	-10-40°C	
WIFI	Requires gateway LENNY-WIFOX1	

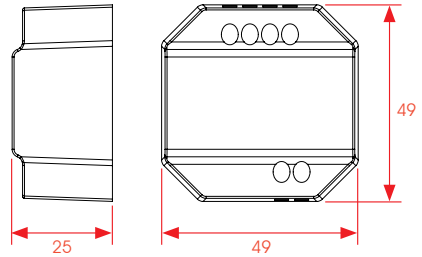

WIFI GATEWAY	
Model	LENNY-WIFOX1
Working voltage	DC5V/500mA (Micro USB)
Working temperature	-20~60°C
Communication	WiFi-IEEE 802.11b/g/n 2.4GHz
Working frequency	2.4GHz
Transmission power	6dBm

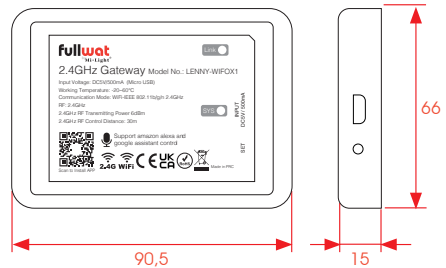

* Suggested AC/DC adaptors (not included): MWMU10GS
FU-ADPY10-5-USB

LENNY-PAN-B4 4 ZONES control

Smart LED control system

SINGLE COLOR

Touch panel functions: LENNY-PAN-B4

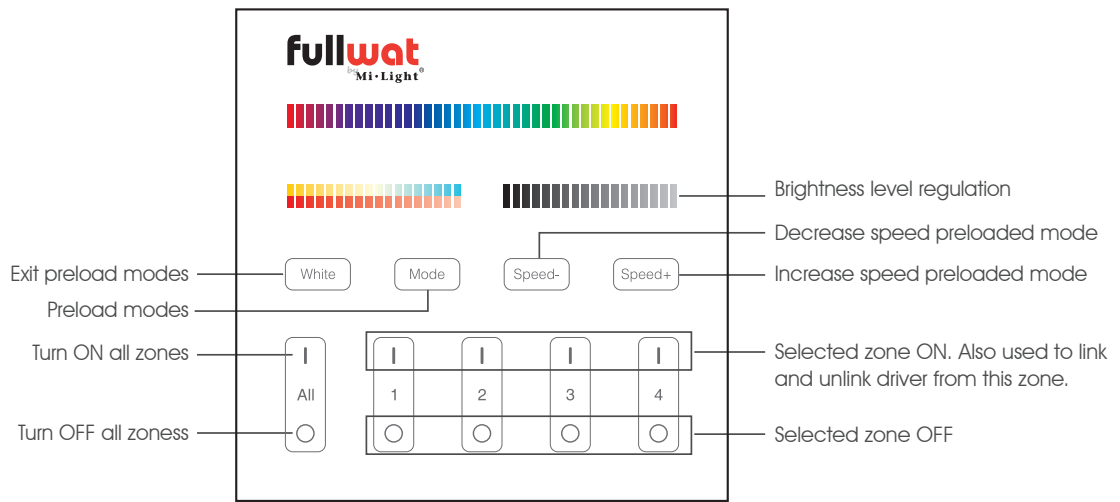

 ALL | : All zones are switched on and can be controlled.

 ALL O: Switching off all zones.

Note: Two zones control at the same time is not possible, neither the other two ones. They must be controlled all together (all 4) or each zone separately.

To activate a zone, click on the “|” symbol from zone number to be controlled.

To deactivate a zone, click on the “O” symbol from zone number to be controlled.

Zone number + | : Switching on of the zone and linking / unlinking of receivers.

Zone number + O: Switching off the zone.

 Mode Preloaded modes. To exit from preloaded mode, press the “White” button.

 Brightness bar: White brightness adjustment.

Note: We need one driver at least per each zone we want to control.

LENNY-PAN-B4 4 ZONES control

Smart LED control system

SINGLE COLOR

Mobile control

For control via mobile phone, Alexa, Google Home or Google Assistant, a WIFI gateway is required, either built into the receiver or using the LENNY-WIFOX1 gateway.

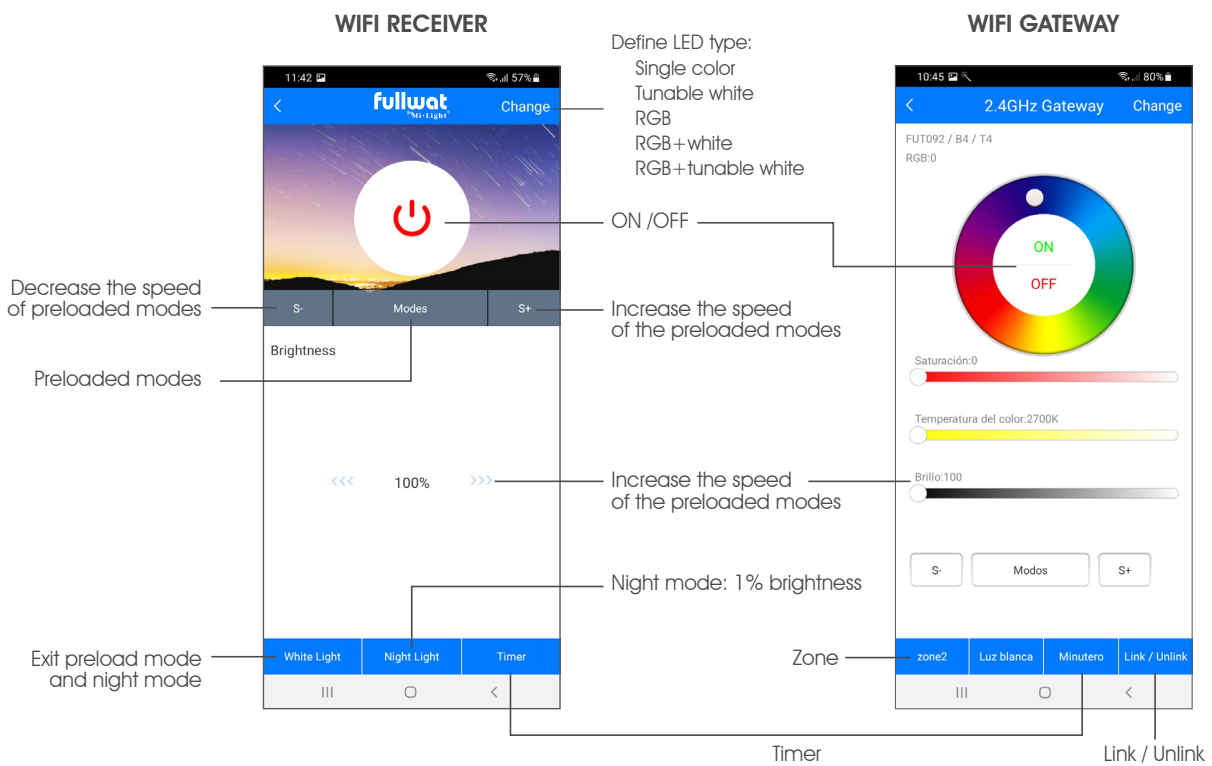



LENNY-PAN-B4 4 ZONES control

Smart LED control system

TUNABLE WHITE

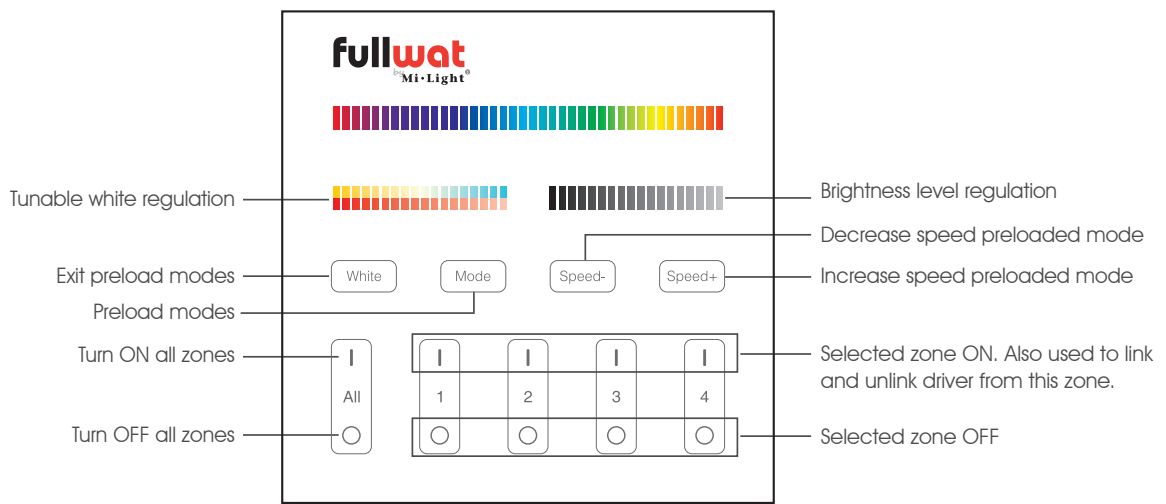
Touch panel functions: LENNY-PAN-B4



 ALL | : All zones are switched on and can be controlled.

 ALL O: Switching off all zones.

Note: Two zones control at the same time is not possible, neither the other two ones. They must be controlled all together (all 4) or each zone separately.

To activate a zone, click on the “|” symbol from zone number to be controlled.

To deactivate a zone, click on the “O” symbol from zone number to be controlled.

Zone number + | : Switching on of the zone and linking / unlinking of receivers.

Zone number + O: Switching off the zone.

 Mode Preloaded modes. To exit from preloaded mode, press the “White” button.

 Brightness bar: White brightness adjustment.

 Dynamic white bar: Adjust Dynamic white from the warmest to the coolest level.

Note: We need one driver at least per each zone we want to control.

LENNY-PAN-B4 4 ZONES control

Smart LED control system

TUNABLE WHITE

Mobile control

For control via mobile phone, Alexa, Google Home or Google Assistant, a WIFI gateway is required, either built into the receiver or using the LENNY-WIFOX1 gateway.

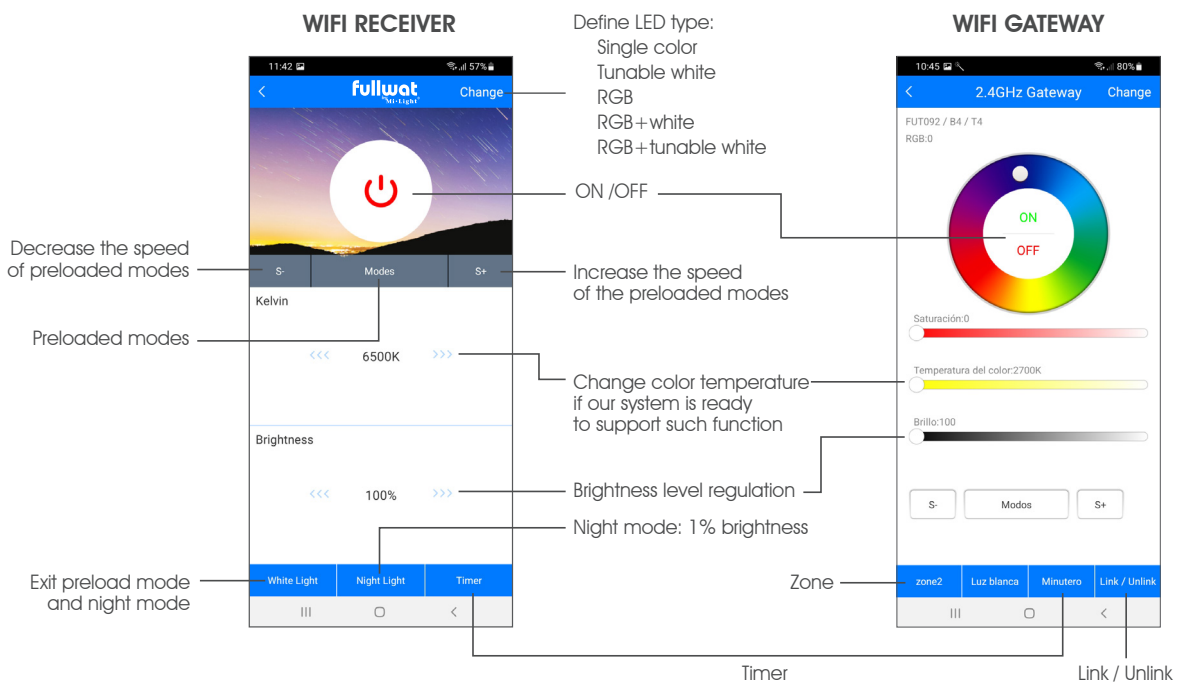

LENNY-PAN-B4 4 ZONES control

Smart LED control system

RGB

Touch panel functions: LENNY-PAN-B4

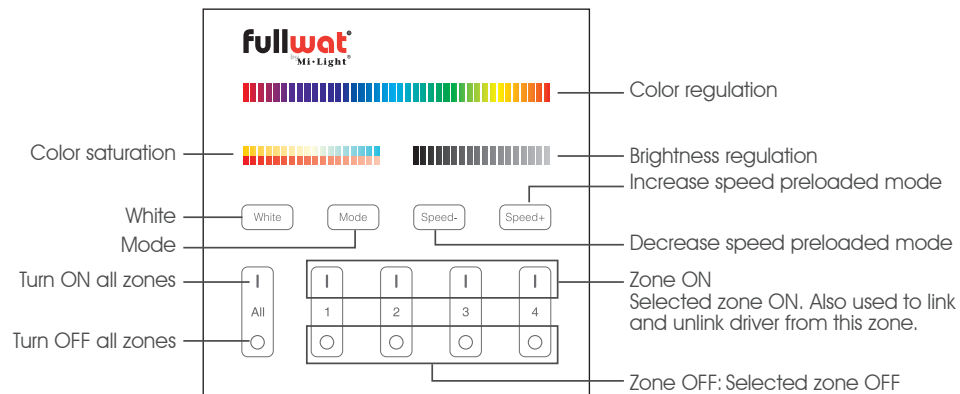

Working mode

- **Select color:** Touch color bar on desired color (e.g. blue).
- **Color saturation:** Adjust color saturation (0% chosen color, 100% very saturated color).
- **Brightness bar:** Adjust brightness level.
- **White:** With any color selected from color wheel, click on "W" to set full white with R+G+B mixing.
 - Brightness slide bar: White brightness level setting.
 - Tunable white: Once white activated, use "color" saturation bar" to set different white tones from RGB leds mixing.
- **ON/OFF for ALL performances.**
 - ON: Control and activation for all zones.
 - OFF: Fully disconnection.

Note: It is not possible to control 2 zones at the same time and not the other 2 ones. They must be controlled either all together (all 4) or each one separately.
- To activate one zone, press "|" symbol from the zone number to be controlled.
To deactivate one zone, press the "O" symbol from the zone number to be controlled.

Note: We need one driver at least per each zone we want to control.

LENNY-PAN-B4 4 ZONES control

Smart LED control system

RGB

Mobile control

For control via mobile phone, Alexa, Google Home or Google Assistant, a WIFI gateway is required, either built into the receiver or using the LENNY-WIFOX1 gateway.



Working mode

- **Select color:** Touch color wheel on desired color (e.g. blue).
- **Saturation:** Adjust color saturation (0% chosen color, 100% very saturated color).
- **Brightness level:** Adjust brightness level.
- **White color:** Bring out white color using R+G+B mixing combination (If maximum level is required, set saturation bar at highest level).
- **Tunable white:** System allows to simulate dynamic white levels using RGB leds.

LENNY-PAN-B4 4 ZONES control

Smart LED control system

RGBW

Touch panel functions: LENNY-PAN-B4

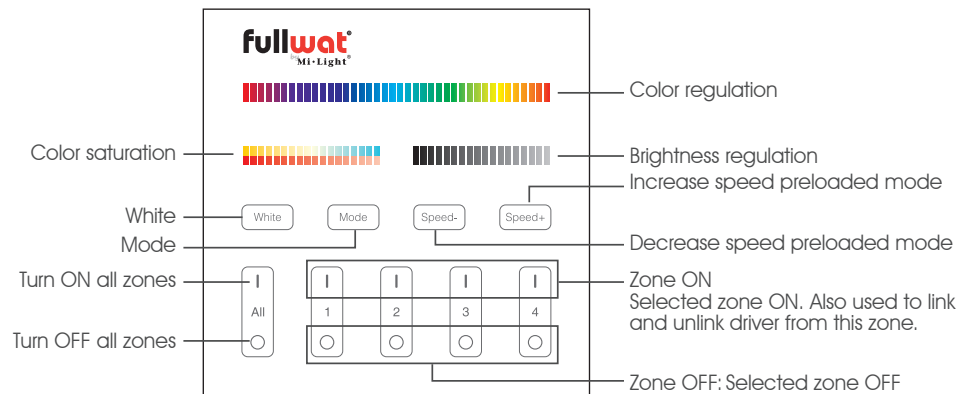

Working mode

- **Select color:** Touch color bar on desired color (e.g. blue).
- **Brightness bar:** Adjust brightness level.
- **Only white activation:** Click on "white" to reach pure white tone.
- **Activate Colour + White:** Choose colour with colour bar and adjust white with slide saturation bar (0% -downwards - white channel off, 100% - upwards - white channel on at maximum).
 - Note: If brightness level was selected when "W" was activated then it will be switched on at that brightness selected level.
- **Colour + White and colour removing:** Press "White".
- **Colour + white and remove white:** slide "white channel control" bar to 0% (to the left).
- **Full ON/OFF**
 - ON full activation: full zones and control access.
 - Full OFF: All zones switch off.

Note: It is not possible to control 2 zones at the same time and not the other 2 ones. They must be controlled either all together (all 4) or each one separately.
- To activate one zone, press the "I" symbol from the zone number to be controlled.
To deactivate a zone, press the "O" symbol from the zone number to be controlled.

Note: We need one driver at least per each zone we want to control.

LENNY-PAN-B4 4 ZONES control

Smart LED control system

RGBW

Mobile control

For control via mobile phone, Alexa, Google Home or Google Assistant, a WIFI gateway is required, either built into the receiver or using the LENNY-WIFOX1 gateway.



Working mode

- **Select color:** Touch color wheel on desired color (e.g. blue).
- **"Saturation" bar:** Adjust color saturation (0% chosen color, 100% very saturated color).
- **Brightness level:** Adjust brightness level.
- **White light:** Only white channel activation set.
– The "Brightness slide bar" is used to set desired brightness level.
- **Color + White activation:** Choose color with "color slide wheel" and set white level with saturation bar (0% white channel off, 100% white channel set at max level).
- **Color + tunable white and turn off white:** We lower the saturation to 0%.
- **Remove Color + white and Color levels:** Press "White light".

LENNY-PAN-B4 4 ZONES control

Smart LED control system

RGBWW

Touch panel functions: LENNY-PAN-B4

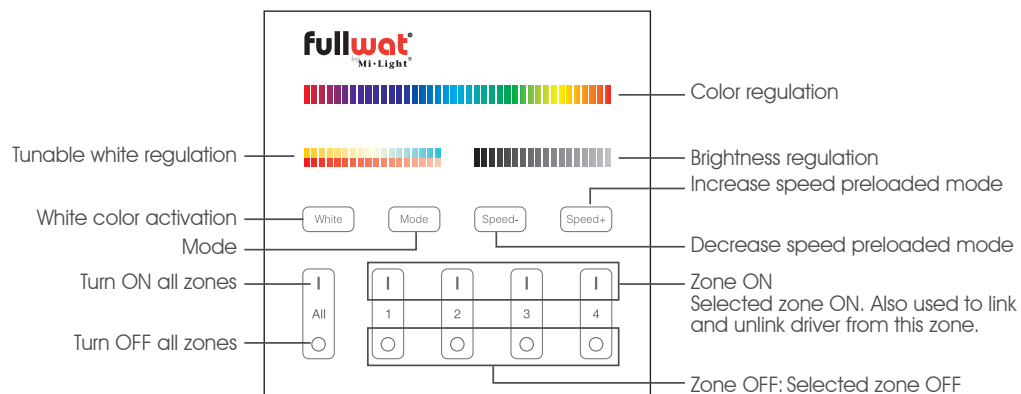

Funcionamiento

- **Select color:** Touch color bar on desired color (e.g. blue).
- **Brightness bar:** Adjust brightness level.
- **Dynamic white control:** Press the "White" key (if there is a previous colour selected, it will be switched off). Move the "dynamic white" bar until the desired tone is achieved.
- **Colour + White activation:** Choose desired shade of white firstly (see previous point). Once we have chosen desired shade of white, we choose colour using the colour bar.
 - Colour + Dynamic white and white removing: slide "dynamic white" bar. 100% to the right (selected white tone will be turned ON to the maximum) and 0% to the left (the white will be turned off and only colour will remain).
 - Colour + Dynamic White and colour removing: press "White" key and adjust desired soft tone.
- **FULL ON/OFF activation.**
 - ON full activation: full zones and control access.
 - Full OFF: All zones switch off.

Note: It is not possible to control 2 zones at the same time and not the other 2 ones. They must be controlled either all together (all 4) or each one separately.
- To activate one zone, press the "I" symbol from the zone number to be controlled.
To deactivate a zone, press the "O" symbol from the zone number to be controlled.

Note: We need one driver at least per each zone we want to control.

LENNY-PAN-B4 4 ZONES control

Smart LED control system

RGBWW

Mobile control

For control via mobile phone, Alexa, Google Home or Google Assistant, a WIFI gateway is required, either built into the receiver or using the LENNY-WIFOX1 gateway.



Working mode

- **Select color:** Touch color wheel on desired color (e.g.blue)
- **Brightness level:** Adjust brightness level.
- **Tunable white:** Slide your finger over "tunable white bar" to get desired white tone.
– Note: If there is a previous selected level from color slide wheel, it will switch off.
- **Color + Dynamic White:** Choose desired color with slide wheel and adjust white tone desired with saturation bar (0% white channel off, 100% white channel at highest level).
– Note: If dynamic white color is desired, please firstly set dynamic white mode.
- **Color + dynamic white and turn white off:** Set saturation bar at lowest level 0%.
- **Color + dynamic white and color off:** Select dynamic white tone with "Kelvin grade" bar and color will be switched off.

LENNY-PAN-B4 4 ZONES control

Smart LED control system

Led Strip-controller connection

Connection drawing

5 in 1 driver **LENNY-DRV-LS2 / LENNY-DRV-WL5**

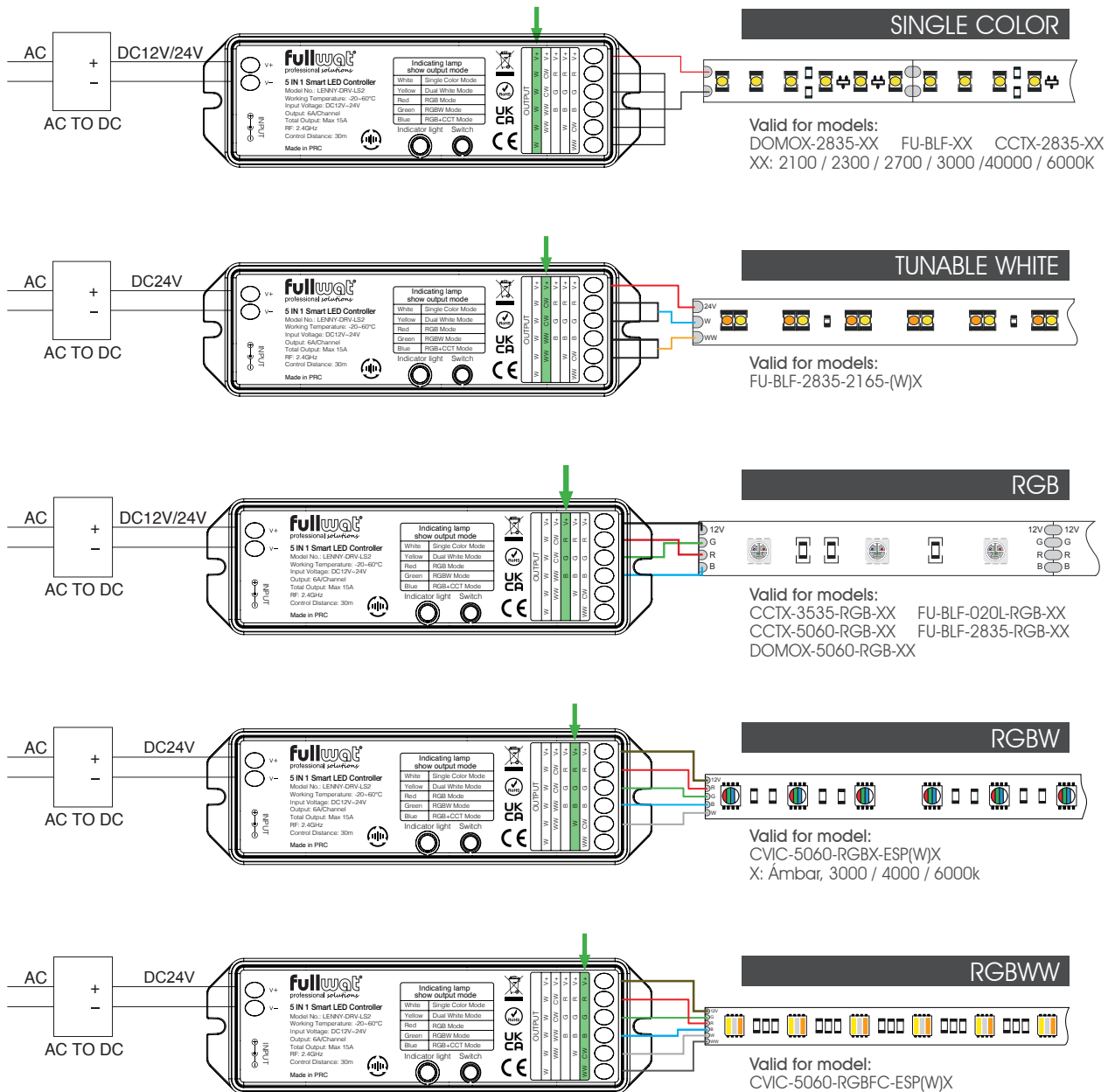

“Switch” button can be used to indicate which type of product is being managed. To do so, press the “Switch” or “SET” button with a short touch until color from “indicator light” is required one.

	Single color	Tunable white	RGB	RGBW	RGBWW
Indicator light	○	●	●	●	●

LENNY-PAN-B4 4 ZONES control

Smart LED control system

Led Strip-controller connection

Connection drawing

2 in 1 driver **LENNY-DRV-WL2P**

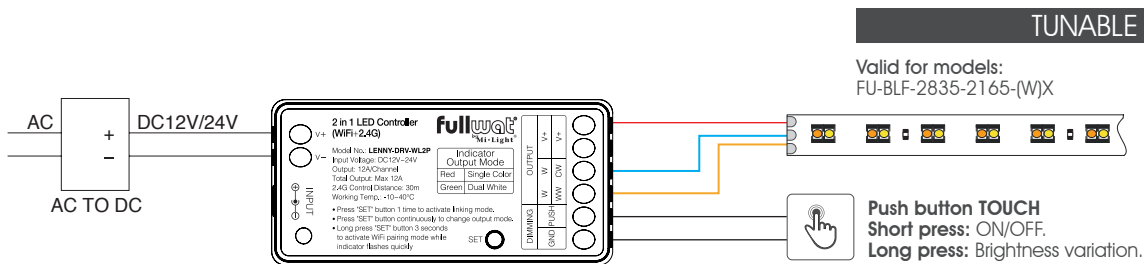
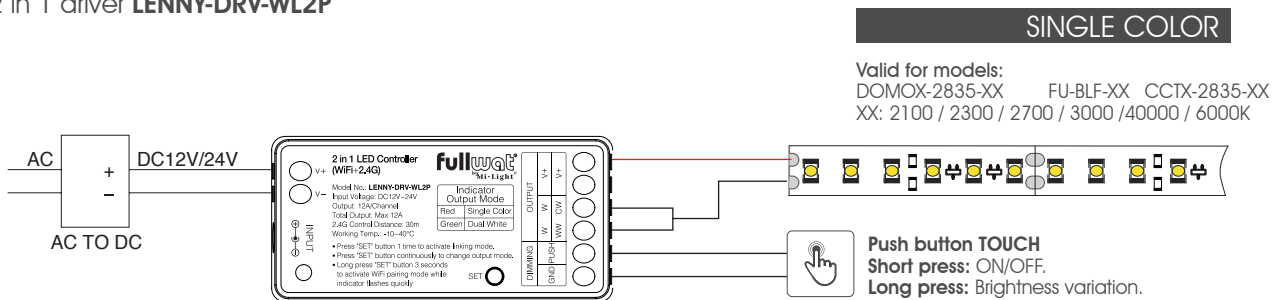

Press "SET" continuously to switch between single color and tunable white mode.

LENNY-TRIAC1 Push button control

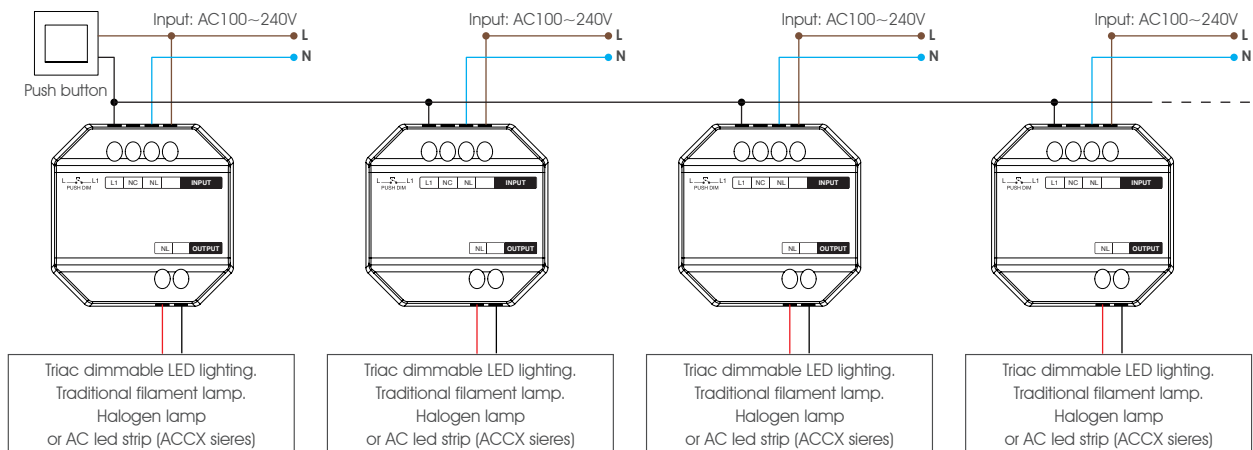

Functioning

Short press: Switches the connected device ON/OFF.

Long press (press and hold): increases or decreases the intensity of the light.

Connection

The maximum number of TRIACs is 25 pieces and maximum wiring distance from the push button is 20m.

To control everything with a single push button, LENNY-TRIACs must be connected in cascade according to the connection diagram.

















LENNY-PAN-B4 4 ZONES control

Smart LED control system

List of LENNY-DRV-LS2 modes and functions for RGB / RGBW / RGBWW

Number	Dynamic mode	Brightness / Saturation / Speed
1	Mardi Gras	Adjustable
2	Automatic colors changing	
3	Sam	
4	Gemma	
5	Twilight	
6	American	
7	Super super Tuesday	
8	Party	
9	Splash colors	

List of LENNY-DRV-WL5 modes and functions for RGB / RGBW / RGBWW

Icon	Dynamic mode	Icon	Dynamic mode	Brightness / Saturation / Speed
	Rainbow		Starlit night	Adjustable
	Swam dancing		Food	
	Carnival		Working	
	Musical show		Relaxing	
	Disco		Reading	
	First love		Sunset	
	Green forest		Good night	
	Trippingly dancing		Night light	

LENNY-PAN-B4 4 ZONES control

Smart LED control system

System linking and unlinking

Note: The light only works after the controller is paired with one or more receivers.

Linking. Place Remote controller close to the desired driver to be paired.

Before starting linking process, configure receiver according to the type of LED strip. Refer to “wiring diagram” section (previous point) from the manual.

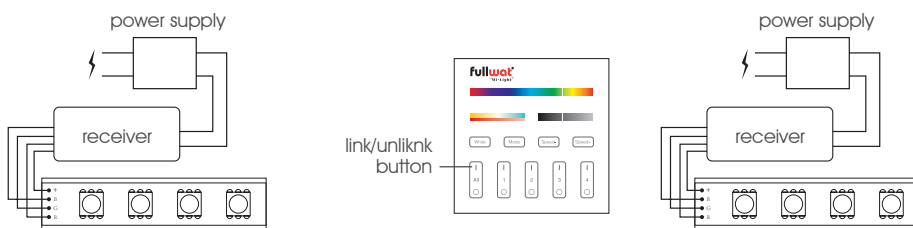

1. Switch off power supply and after 10 seconds, switch it on again.

2. Press ON button on the remote control 3 times within a maximum period of 3 sec.

3. The light will flash 3 times slowly to indicate successful pairing.

Note: For LENNY-DRV-WL2P or LENNY-TRIAC1, press the SET button once to enter pairing mode.



If light does not flash slowly, the bonding is not done. Repeat the process until this occurs.

Unlinking

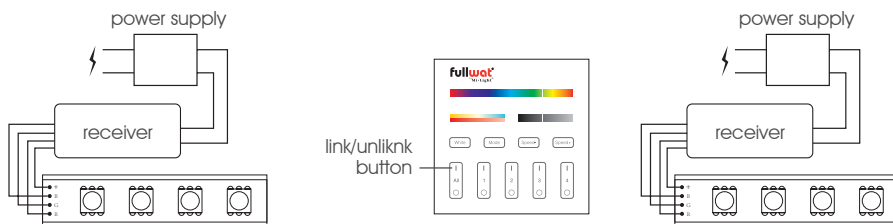

1. Switch off power supply and after 10 seconds, switch it on again.

2. Press ON button on the remote control 5 times within a maximum period of 3 sec.

3. The light will flash 10 times rapidly to indicate that unlinking is successful.

Note: For LENNY-DRV-WL2P or LENNY-TRIAC1, press the SET button once to enter pairing mode.



If light does not flash quickly, the bonding is not done. Repeat the process until this occurs.

Attention

- 1. ⚠ Please check if input voltage is compatible with voltage supported by the driver. Pay special attention not to cross positive and negative poles. Reversed connection will damage the controller.**
2. Do not connect the cables while the power supply is on. Turn it on when you are sure of connections are correct and there is no short circuit is possible.
3. Avoid placing driver controller in areas influenced by electromagnetic fields or close to devices that produce electromagnetic fields. Also, do not place driver controller in areas shielded by metal surfaces or where metal surfaces come between the control and the controller. This would affect operating distance effectiveness.

LENNY-PAN-B4 4 ZONES control

Smart LED control system

Device auto-sync

Different receiver drivers can be connected to operate with the same remote controller and operate in the same modes.

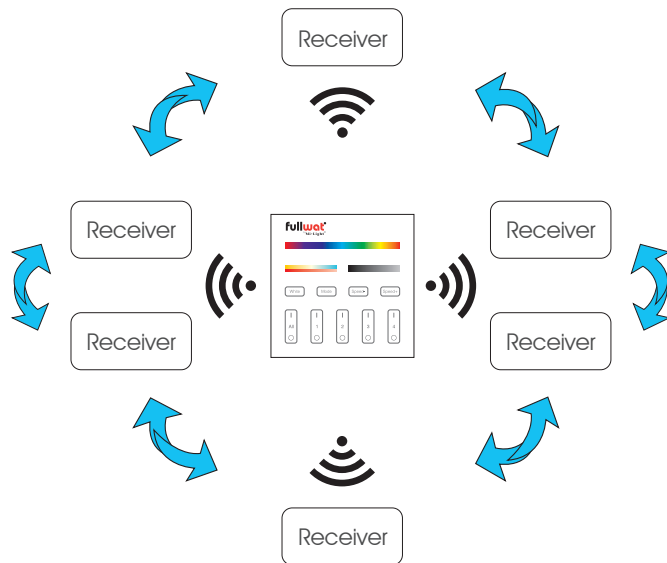

Notes:

1. : Self emitting indication.
2. Remote driver controllers can be paired with the same remote controller within a maximum range of 30 meters. (possible where as free or semi-free spaces and without too many obstacles or walls).

Auto-transmitting function

A single remote controller may transmit control signals in succession to other driver controllers provided if maximum coverage distance of 30m is respected between them.

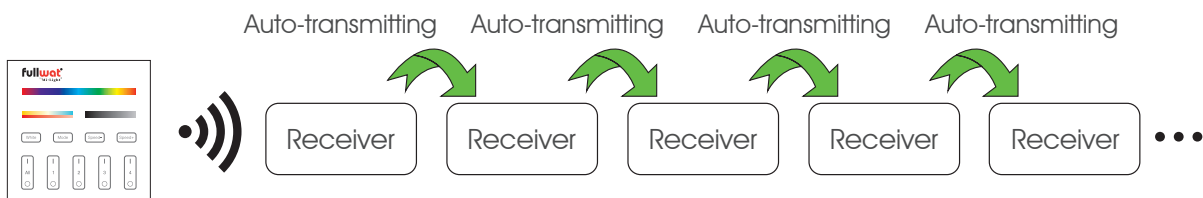

LENNY-PAN-B4 4 ZONES control

Smart LED control system

Installation diagram - LENNY-PAN-B4

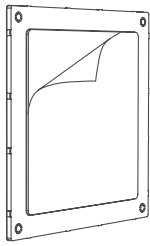

1
Remove rear adhesive foil tape

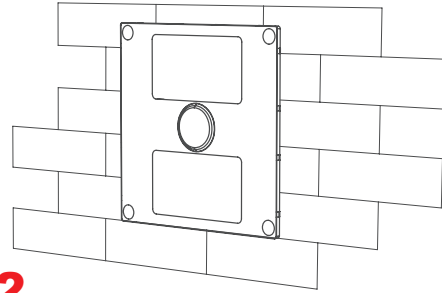

2
Place bracket on the wall with your desired position.

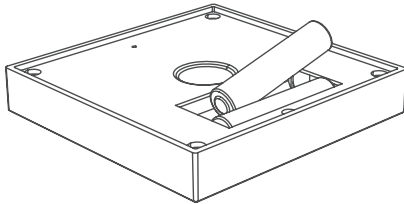

3
Install 2 pcs AAA alkaline batteries.

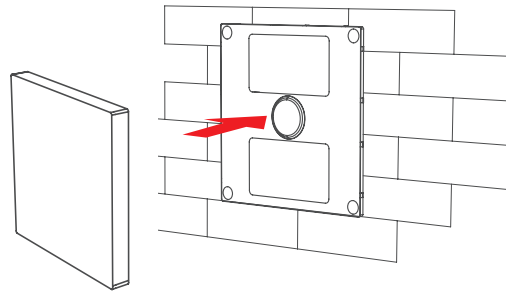

4
Place main panel on the front of the bracket.

LENNY-PAN-B4 4 ZONES control

Smart LED control system

Installation diagram - LENNY-TRIAC 1

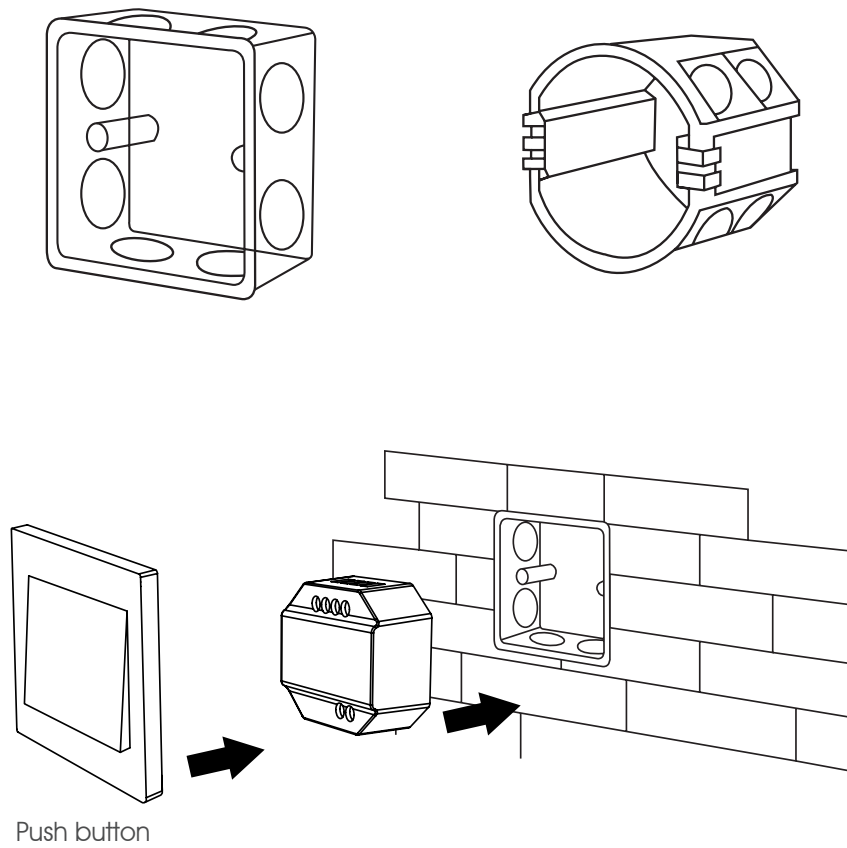

LENNY-PAN-B4 4 ZONES control

Smart LED control system

Mobile phone pairing

Download and install the application on your mobile phone:

- Via QR code
- Searching the Play Store for "MiBoxer".



Note:

Also compatible with the application: SMART LIFE

To link our installation with our mobile phone, we will need one of these drivers:

- LENNY-DRV-WL5
- LENNY-DRV-WL2P
- LENNY-DRV-LS2 + LENNY-WIFOX1
- LENNY-TRIAC1 + LENNY-WIFOX1

Register in MiBoxer:

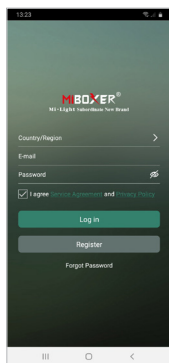

Insert your email address

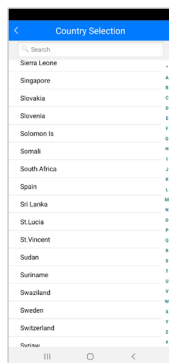

Insert your country

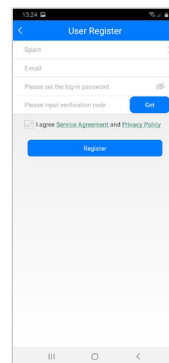

Choose password

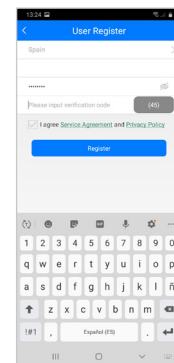

Accept conditions and terms

We will receive an e-mail with a registration verification code, which we will have to enter in the application to finish registering account.

In order to use the application, we must activate GPS on our mobile phone (either Android or Apple).

Once on the main screen and our session started, we must add the device. To do this:

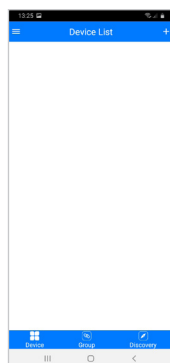

Push "+" to add device

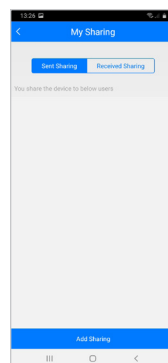

Push "add sharing".

LENNY-PAN-B4 4 ZONES control

Smart LED control system

Mobile phone pairing

Select device model:



For model LENNY-DRV-WL5:

Click on "Smart Strip Controller (WL5)".

For model LENNY-DRV-WL2P:

Click on "LED controller (FUT035W-FUT039W)".

For model LENNY-DRV-LS2 or model LENNY-TRIAC1:

Click on "2.4GHz Gateway (WL-Box1)".

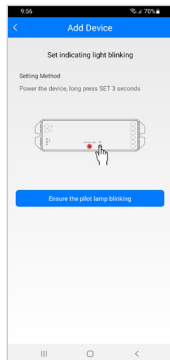

For model LENNY-DRV-WL5:

Disconnect power supply from LENNY-DRV-WL5 for 10 sec.

After 10 seconds, power the controller and within the first three seconds, press and hold "SET" button on the receiver until LED on the receiver flashes.

For models LENNY-DRV-WL2P / LENNY-DRV-LS2 / LENNY-TRIAC1:

Press SET button on device or on WIFI gateway for 3 seconds to activate WIFI signal.

In both cases, on the phone screen, click on "Ensure pilot lamp blinking".

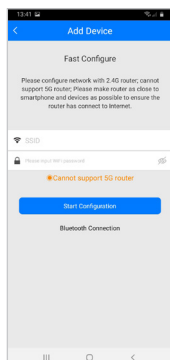

Enter network name and password.

Attention: only 2.4GHz network is supported (no 5G) and click on "Start configuration".

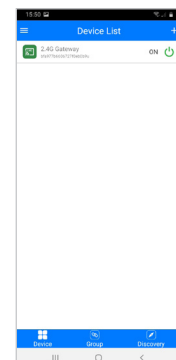
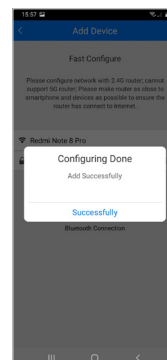
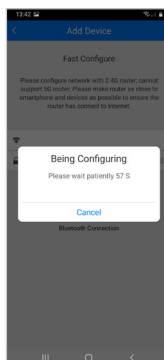

A countdown will appear and once paired, it will indicate that pairing has been successful.

Our device will appear in the list of paired devices.

LENNY-PAN-B4 4 ZONES control

Smart LED control system

Vinculación con teléfono móvil

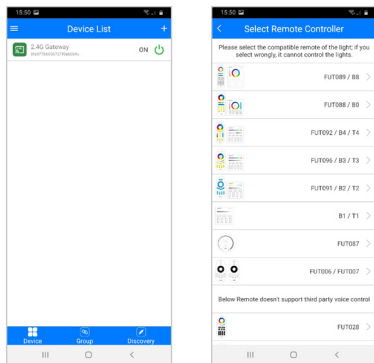

Whether we have to use the WIFI gateway (LENNY-WIFOX1):

We must link the driver to be controlled via the APP. To do this, click on 2.4GHz gateway.

First we must choose whether we are going to configure one or more zones. In this case, as it is a zone, we enter the "change" section and select FUT092/B4/T4.

On the screen of our mobile phone we will see image as follows:

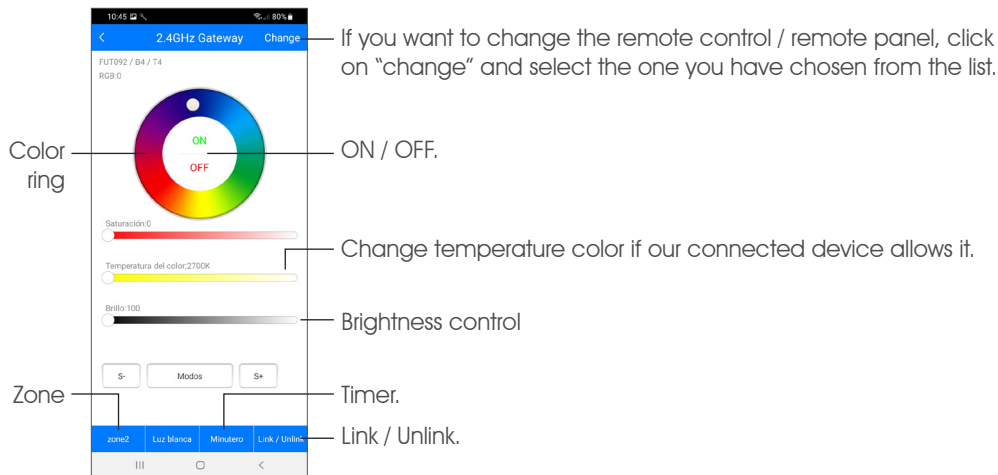

Click on "Link/Unlink".

Click on "link" to link and on "unlink" to unlink.

Remove the power supply to controller for 10 seconds.

After 10 seconds, power the controller and in the first 3 seconds, click on the mobile screen on "link" or "unlink".

The light will flash three times and confirm correct linking.

In the case of unlink, light will flash 10 times for confirmation.

LENNY-PAN-B4 4 ZONES control

Smart LED control system

Mobile phone pairing

The application allows us to create groups with different receivers. This will allow us to control several receivers at the same time: turn ON / OFF / change the color, etc.

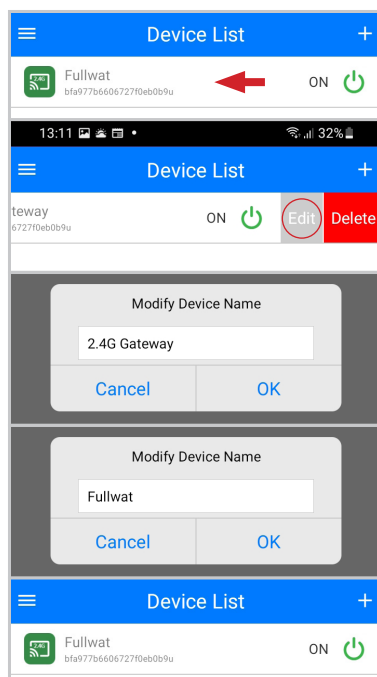
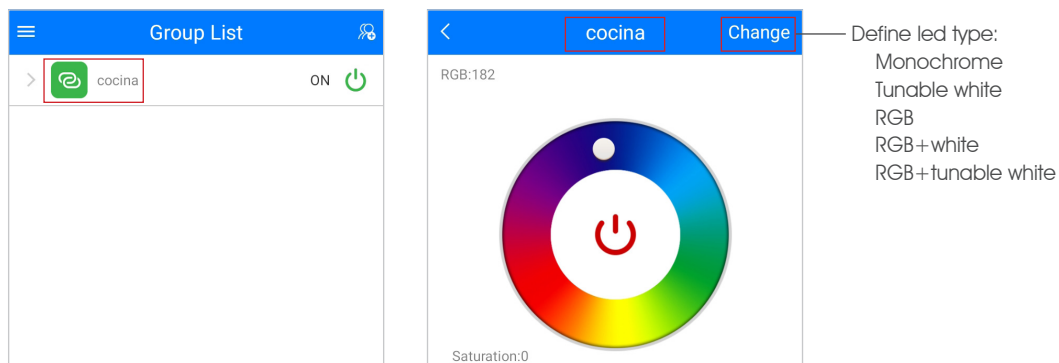
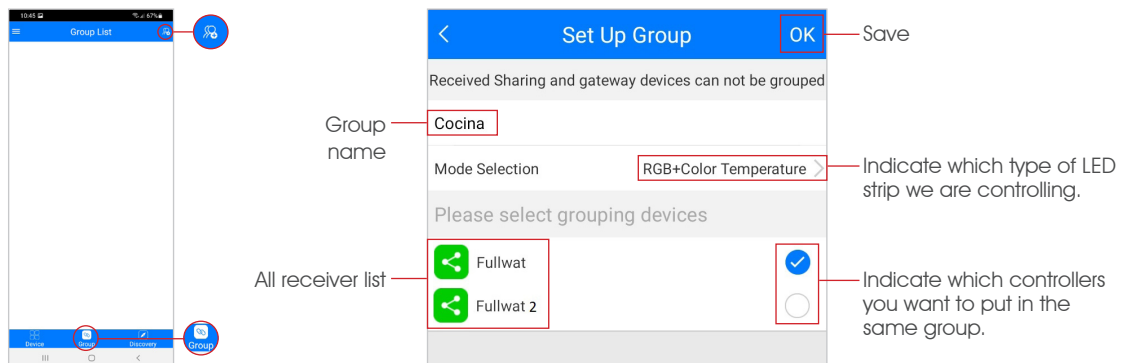

Once we have linked our receiver we can change our device name. This is interesting if we are going to control it with Alexa, Google Assistant or Google Home.

To do so, we press and hold name of the device on the screen and move it to the left. We will see an "edit" and a "delete". Click on "Edit", change the name and "Ok".

LENNY-PAN-B4 4 ZONES control

Smart LED control system

ALEXA linking

To control system with Alexa, a wifi gateway is required, either built into receiver or using LENNY-WIFOX1 gateway.
Install Alexa app and log in using your account.
We need to install Mi-Light Smart skill. To do so:

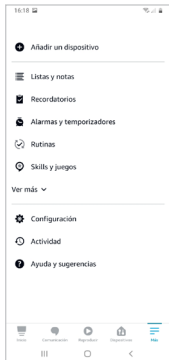

Click on "more" and select "Skill and games".



In the search engine type "Mi-Light Smart" and click on this option.



We allow application using.

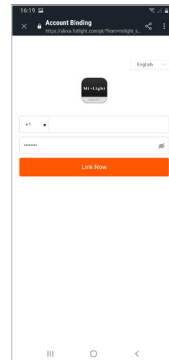

Log in with your MiBoxer data.



If everything is correctly done, we will see a message of successful linking

Once reached step as above, Alexa will detect our receiver automatically and we will be able to change its name, include it in a group or control it by voice.

If receiver is not detected automatically, we can push "detect devices" via Alexa app function.

Now you can work with standard ALEXA managing.

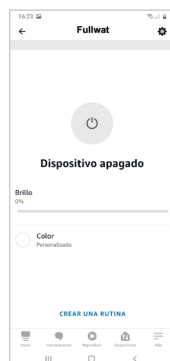
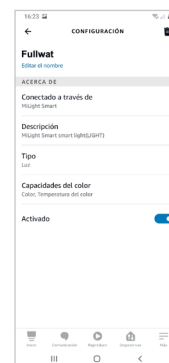
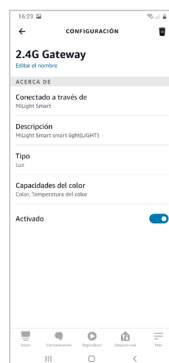

We can rename device to be able to control that device only instead the whole group, command Alexa to turn off/on the device, etc.

LENNY-PAN-B4 4 ZONES control

Smart LED control system

GOOGLE HOME linking

To control system with Google Home, a wifi gateway is required, either built into the receiver or using LENNY-WIFOX1 gateway.

Install Google Home app and log in with your Google account. If you have not yet configured your home, you can do this now or later.

We need to install Mi-Light Smart skill. To do this:

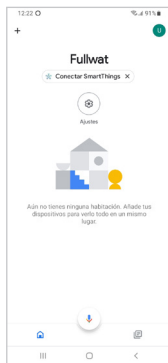

Click on "more".

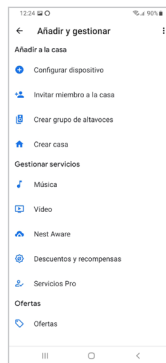

Select "Configure device".

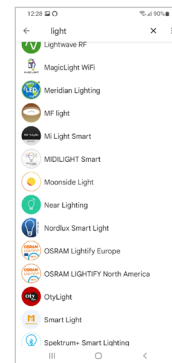

Look for the "Mi-Light Smart" application in the list of applications.

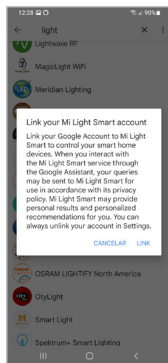

You may get a link warning message. Click on "Link" to accept.



Log in with your MiBoxer data.



If we do it correctly, a successful linking message will appear.

Once we have reached this point, the linking is done.

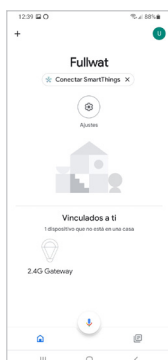

On the main Google Home screen, our home will appear with our device.

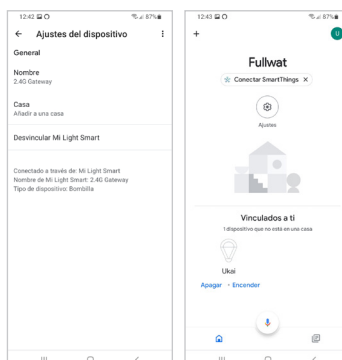

We can rename device to make "name it" easier.

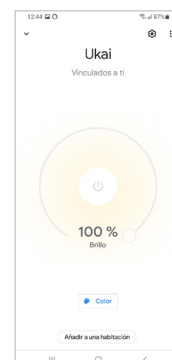

Clicking on the device icon, you are reaching another page where you can control the lights too.



LENNY-PAN-B4 4 ZONES control

Smart LED control system

GOOGLE ASSISTANT linking

To control system with Google Assistant, a wifi gateway is required, either built into the receiver or using LENNY-WIFOX1 gateway.

And Install Google Assistant application via PlayStore on your phone:



We must configure it to recognize your voice. Then enter "settings" in the application and click on "Voice Match".

The application will ask you to repeat two phrases several times.

Once this is done, we will be able to "call" our device using "Ok Google". For example, "Ok Google turn on Fullwat" and LED strips connected to Fullwat receiver will light up properly.

LENNY-PAN-B4 4 ZONES control

Smart LED control system

Compatibility table

	Single color	CCT	RGB	RGBW	RGBWW	"Mobile app Alexa Google Home"	Zones
LENNY-DRV-LS2 LENNY-DRV-LS2S 5-in-1 standard receiver	LENNY-MD-085	LENNY-MD-085				LENNY-WIFOX1 gateway is required	1
	LENNY-MD-086	LENNY-MD-086	LENNY-MD-086	LENNY-MD-086	LENNY-MD-086		1
	LENNY-MD-087						1
	LENNY-MD-088	LENNY-MD-088	LENNY-MD-088	LENNY-MD-088	LENNY-MD-088		1
	LENNY-PAN-B0	LENNY-PAN-B0	LENNY-PAN-B0	LENNY-PAN-B0	LENNY-PAN-B0		1
	LENNY-PAN-K1	LENNY-PAN-K1					1
	LENNY-MD-007	LENNY-MD-007					4
	LENNY-MD-092	LENNY-MD-092	LENNY-MD-092	LENNY-MD-092	LENNY-MD-092		4
	LENNY-PAN-B4	LENNY-PAN-B4	LENNY-PAN-B4	LENNY-PAN-B4	LENNY-PAN-B4		4
	LENNY-MD-089	LENNY-MD-089	LENNY-MD-089	LENNY-MD-089	LENNY-MD-089		8
	LENNY-PAN-B8	LENNY-PAN-B8	LENNY-PAN-B8	LENNY-PAN-B8	LENNY-PAN-B8		8
LENNY-DRV-WL5 5 in 1 wifi receiver	LENNY-MD-085	LENNY-MD-085				included	1
	LENNY-MD-086	LENNY-MD-086	LENNY-MD-086	LENNY-MD-086	LENNY-MD-086		1
	LENNY-MD-087						1
	LENNY-MD-088	LENNY-MD-088	LENNY-MD-088	LENNY-MD-088	LENNY-MD-088		1
	LENNY-PAN-B0	LENNY-PAN-B0	LENNY-PAN-B0	LENNY-PAN-B0	LENNY-PAN-B0		1
	LENNY-PAN-K1	LENNY-PAN-K1					1
	LENNY-MD-007	LENNY-MD-007					4
	LENNY-MD-092	LENNY-MD-092	LENNY-MD-092	LENNY-MD-092	LENNY-MD-092		4
	LENNY-PAN-B4	LENNY-PAN-B4	LENNY-PAN-B4	LENNY-PAN-B4	LENNY-PAN-B4		4
	LENNY-MD-089	LENNY-MD-089	LENNY-MD-089	LENNY-MD-089	LENNY-MD-089		8
	LENNY-PAN-B8	LENNY-PAN-B8	LENNY-PAN-B8	LENNY-PAN-B8	LENNY-PAN-B8		8
LENNY-DRV-WL2P 2 in 1 receiver with wifi and push button	LENNY-MD-085	LENNY-MD-085				included	1
	LENNY-MD-086	LENNY-MD-086					1
	LENNY-MD-087						1
	LENNY-MD-088	LENNY-MD-088					1
	LENNY-PAN-B0	LENNY-PAN-B0					1
	LENNY-PAN-K1	LENNY-PAN-K1					1
	LENNY-MD-007	LENNY-MD-007					4
	LENNY-MD-092	LENNY-MD-092					4
	LENNY-PAN-B4	LENNY-PAN-B4					4
	LENNY-MD-089	LENNY-MD-089					8
	LENNY-PAN-B8	LENNY-PAN-B8					8
LENNY-TRIAC1 Driver TRIAC	LENNY-MD-085					LENNY-WIFOX1 gateway is required	1
	LENNY-MD-086						1
	LENNY-MD-087						1
	LENNY-MD-088						1
	LENNY-PAN-B0						1
	LENNY-PAN-K1						1
	LENNY-MD-007						4
	LENNY-MD-092						4
	LENNY-PAN-B4						4
	LENNY-MD-089						8
LENNY-PAN-B8					8		

LENNY-PAN-B4 4 ZONES control

Smart LED control system

Table of controls by zones

1 ZONE



LENNY-MD-085



LENNY-MD-086



LENNY-MD-087



LENNY-MD-088



LENNY-MD-B0



LENNY-PAN-K1

4 ZONES



LENNY-MD-007

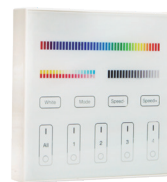

LENNY-PAN-B4



LENNY-MD-092

8 ZONES



LENNY-MD-089



LENNY-PAN-B8