

side view neon NL-0408H-BX



Flame
Protected



Resistant
to solvents



Saltwater
resistant



UV resistant



IP67 Immersion
Protection



LK08
protection



Beam
angle

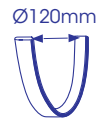

Min. bending
diameter

BRIEF PARAMETERS

| | |
|-----------------------|------------|
| Forward Voltage: | 24VDC |
| Power: | <8W/m |
| Led color: | White |
| Wave length: | 2700-4000K |
| Width: | 8mm |
| Thickness: | 4mm |
| Min. Bending diameter | ≥120mm |
| IP grade | IP67 |

SIDE VIEW
Horizontal Bending
Horizontal bending against
the light surface

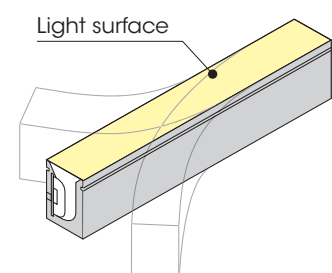
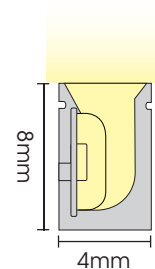

PRODUCT FEATURES

- Dimension: 8x4mm.
- Led strip inside: 280led/m SMD2216.
- Special design, still works however inner FPC board damaged in one or more pieces.
- Constant voltage, Max. run (single end feed): 5m/pcs, 50mm as a min. section with the fast connectors.
- With matte treatment, smooth surface and resistant to dust.

OPTICAL PARAMETER

| Item | Color/CCT | Lumen/m | Power/m | Voltage | Light efficiency | CRI (Ra) | Max. Run (single end feed) | Minimum section | Color tolerance |
|---------------|-----------|---------|---------|---------|------------------|----------|----------------------------|-----------------|-----------------|
| NL-0408H-BH | 2700K | 170Lm | <8W | 24VDC | 22Lm/W | 90+ | 5m | 50mm | SDCM<3 |
| NL-0408H-BC | 3000K | 170Lm | <8W | 24VDC | 22Lm/W | 90+ | 5m | 50mm | SDCM<3 |
| NL-0408H-BCN* | 3500K | 190Lm | <8W | 24VDC | 24Lm/W | 90+ | 5m | 50mm | SDCM<3 |
| NL-0408H-BN | 4000K | 210Lm | <8W | 24VDC | 27Lm/W | 90+ | 5m | 50mm | SDCM<3 |

* Available under request.

DIMENSIONS AND OUTLET DIRECTION

Unit: mm

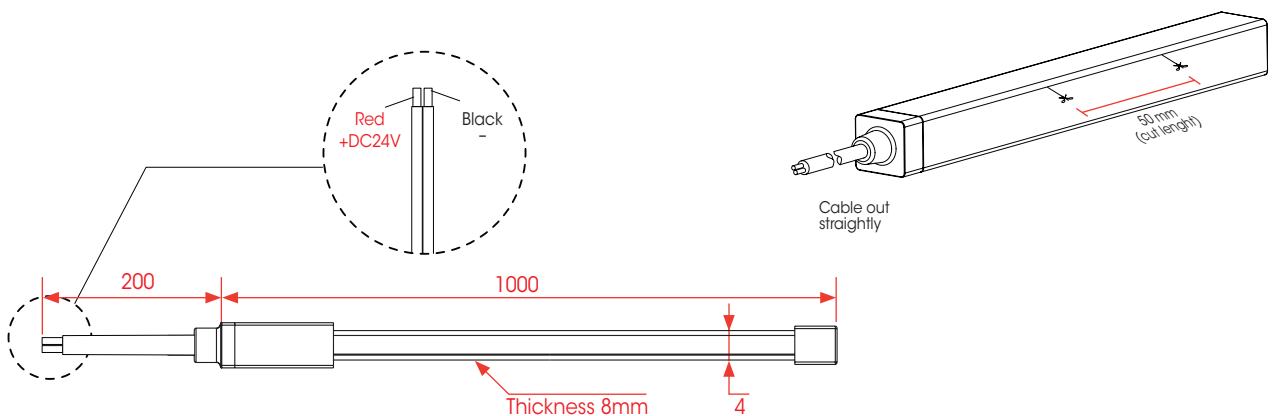

Notice: End cap with the same width as the tape light.

NEON LED STRIP INSTRUCTION AND CAUTION

Light Profile

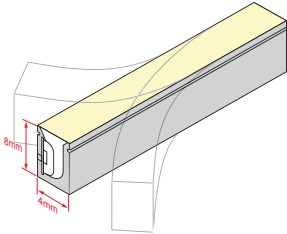

Correct bending way

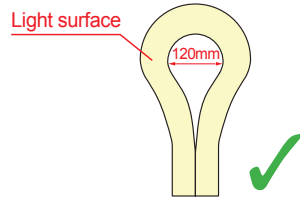

Face to the light surface fold the strip, the minimum bending diameter is 120mm.

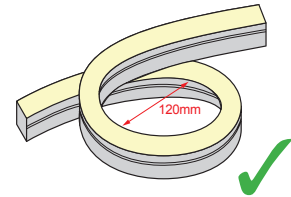

Light surface upwards, the strip is bendable to right or left naturally, the minimum bending diameter is 120mm.

Bending direction Profile

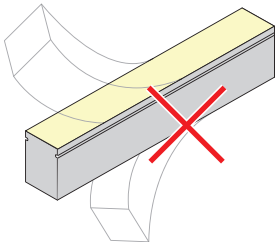
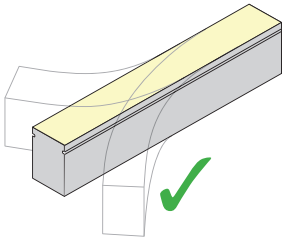

Incorrect bending way



Face to the side surface, (as the picture shows) Do not bend downward to damage the strip.

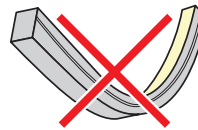

Face to the side surface, (as the picture shows) Do not bend upward to damage the strip.



(as the picture shows) please do not twist the strip, or it will be damaged.

PACKAGING

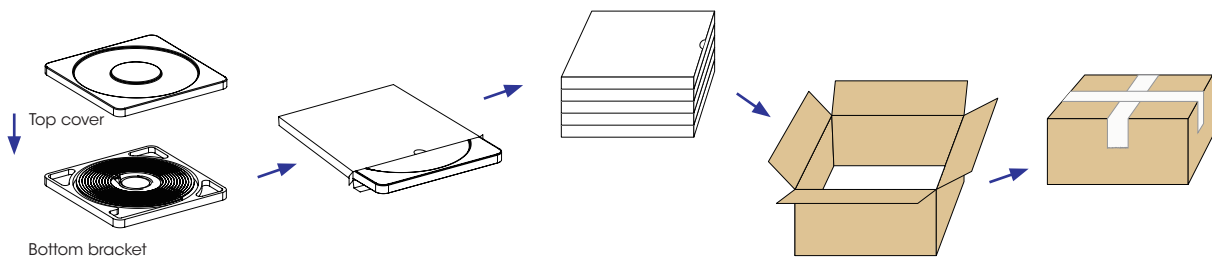

10 pcs/carton
17.5KG/carton
carton size: 41x38.5x38.5cm