

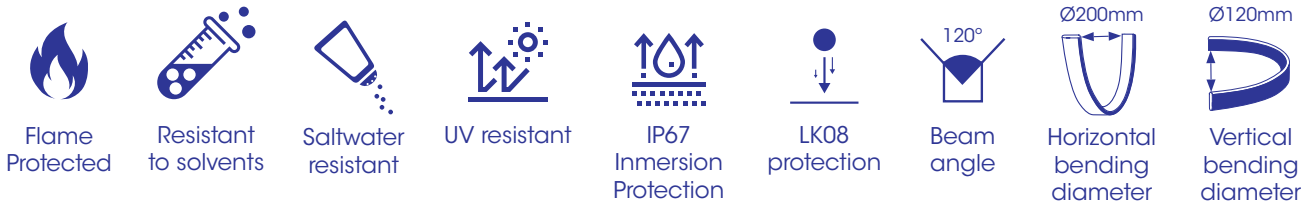

3D freely bending NL-1010F-BX



BRIEF PARAMETERS

Forward Voltage:	24VDC
Power:	<10W/m
Led color:	White
Wave length:	2700-6500K
Width:	10mm
Thickness:	10mm
Min. Horizontal bending diameter	≥200mm
Min. Vertical bending diameter	≥120mm
IP grade	IP67 / IP65 (Depending on the connectors used: factory or mounted)

3D FREELY BENDING Vertical Bending and Horizontal Bending

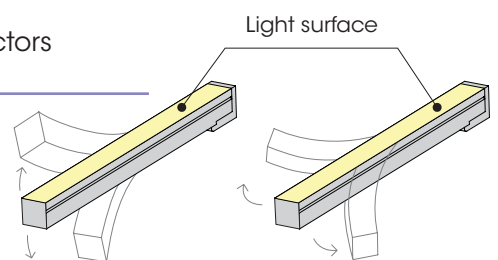
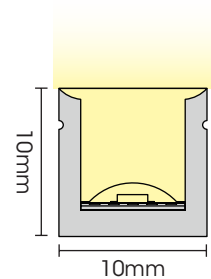

PRODUCT FEATURES

- Led strip inside: 96led/m SMD2835.
- Dimension: 10x10mm.
- 3D bending neonflex, IP67 silicone extrusion.
- Dot free and perfectly homogeneous linear LED light.
- 10mm x 10mm / 0.4"x0.4" (W x H) (±0.5mm).
- Vertical and horizontal bending with bending diameter over 120mm (Vertical) and over 200mm (Horizontal).
- Offering the ideal solution for any indoor/outdoor organic facade geometry.

OPTICAL PARAMETER

Item	Color/CCT	Lumen/m	Power/m	Voltage	Light efficiency	CRI (Ra)	Max. Run (single end feed)	Minimum section	Color tolerance
NL-1010F-BH	2700K	590Lm	<10W	24VDC	59Lm/W	90+	5m	Freely cutting	SDCM<5
NL-1010F-BC	3000K	600Lm	<10W	24VDC	60Lm/W	90+	5m	Freely cutting	SDCM<5
NL-1010F-BN	4000K	690Lm	<10W	24VDC	69Lm/W	90+	5m	Freely cutting	SDCM<5
NL-1010F-BF	6500K	690Lm	<10W	24VDC	69Lm/W	90+	5m	Freely cutting	SDCM<5

LUMINOUS INTENSITY DISTRIBUTION DIAGRAM

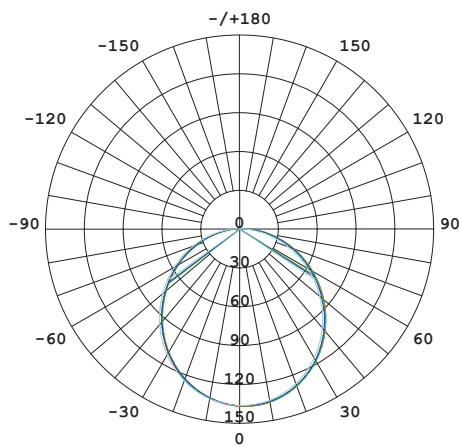

AVERAGE BEAM ANGLE(50%):110.8 DEG
UNIT: cd

- C0/180,111.0 I_c=136.9
- C30/210,110.8 I_c=136.7
- C60/240,110.6 I_c=136.4
- C90/270,110.9 I_c=136.1

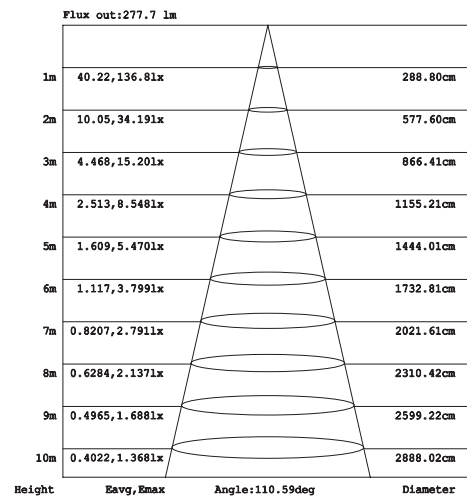

DIMENSIONS AND OUTLET DIRECTION

Unit:mm

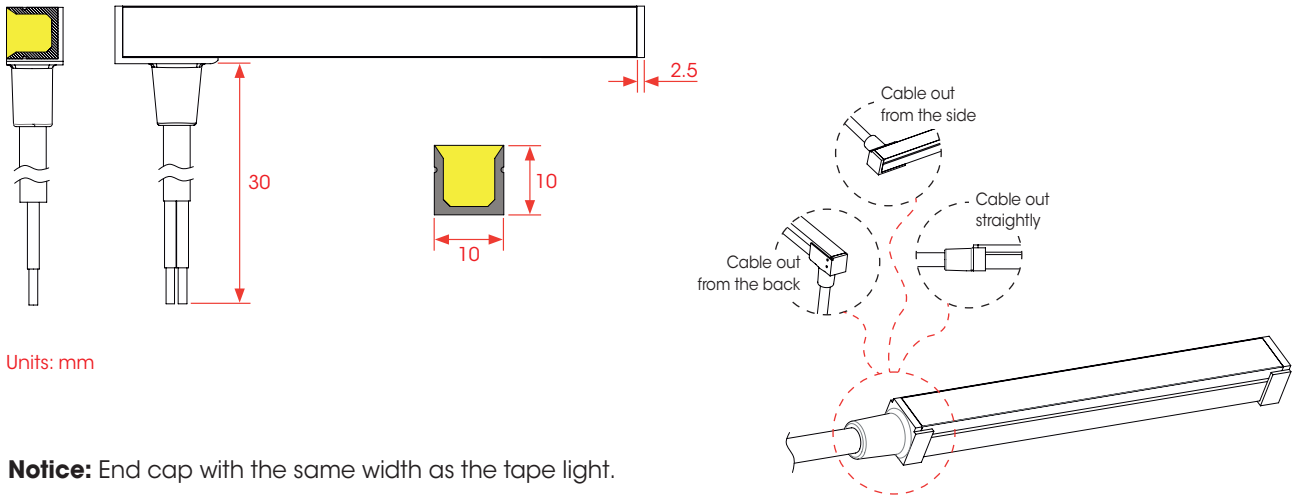

Units: mm

Notice: End cap with the same width as the tape light.

INSTALLATION ACCESSORIES

Aluminium Buckle - NL-1010-CLIP
12x12.5x25mm

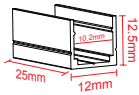

Screw
15x3.5mm

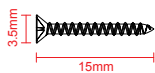

Lenght	25mm
Buckle	4pcs
Screw	4pcs

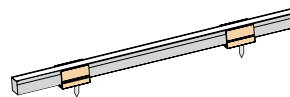

Aluminium profile - NL-1010-PF-AL
12x12.5x2440mm

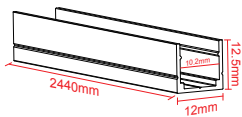

Screw
15x3.5mm

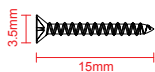

Lenght	2440mm
Screw	3pcs

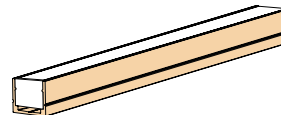

Flexible channel - NL-1010-PF-S
12x12.5x2020mm

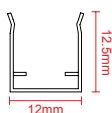

Lenght	2020mm
Buckle	4pcs
Screw	4pcs

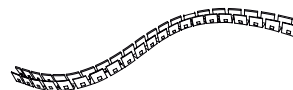

CONNECTING ACCESSORIES (IP65)

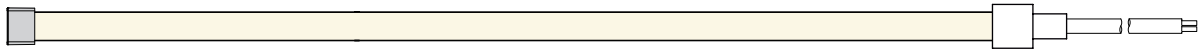

Initial cap with straight cable hole
NL-1010-CAP-I



Assembly end cap
NL-1010-CAP

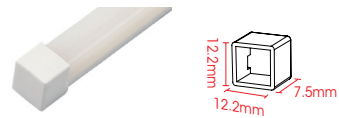

PACKAGING

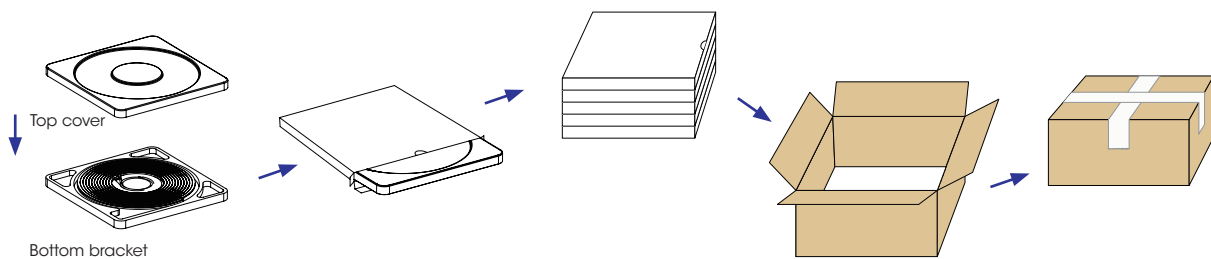

Light length	Plastic box dimension	White box dimension	Numbers of white box	Carton dimension
1m	275x275x30.5mm	275x35x275mm	40pcs	570x570x380mm
5m	385x385x35.5mm	385x39x385mm	10pcs	405x405x420mm

NEON LED STRIP INSTRUCTION AND CAUTION

Light profile

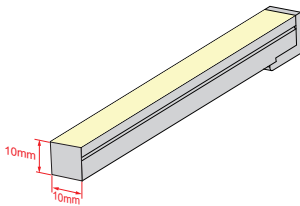

Correct bending way

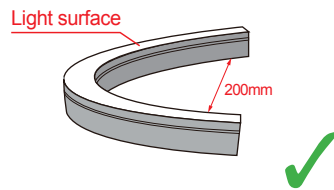

Horizontal bending
diameter >200mm

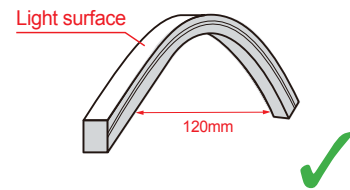

Vertical bending
bending diameter >120mm

Bending direction profile

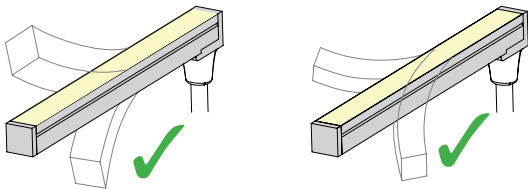

Incorrect bending way

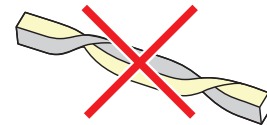

(as the picture shows)
please do not twist
the strip, or it will be
damaged.