

NL-1515V-PXL

DMX SMART RGB front view neon



BRIEF PARAMETERS

Forward Voltage:	24VDC
Power:	<14.4W/m
Led color:	DMX SMART + RGB
Wave length:	Red: 600nm-625nm Green: 520nm-530nm Blue: 465nm-470nm
Luminous flux:	200lm/m
Width:	15mm
Thickness:	15mm
Min. Bending diameter:	≥190mm
IP grade:	IP67 / IP65 (Depending on the connectors used: factory or mounted)

FRONT VIEW
Vertical Bending
Vertical bending against
the light surface

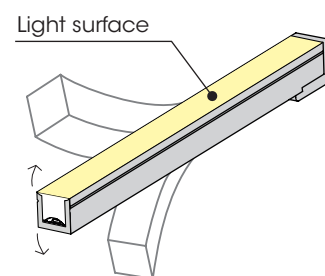
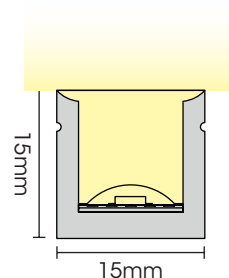

PRODUCT FEATURES

- Dimension: 15x15mm. Vertical Bending. Color: RGB.
- Led strip inside: 70leds/m SMD5050.
- Easy installing for many ways.
- Can be cutting into small units (with a "scissors" sign on the LED strip) or connecting at your will.
- Adjustable for all kinds of LED decorations.

OPTICAL PARAMETER

Item	Color/CCT	Lumen/m	Power/m	Voltage	Light efficiency	Max. Run (single end feed)	Minimum section
NL-1515V-PXL	RGB	200Lm	14.4W	24VDC	14Lm/W	5m	100mm
	(R) 600-625nm						
	(G) 520-530nm						
	(B) 465-470nm						

WIRING DIAGRAM AND OUTLET DIRECTION

Unit:mm

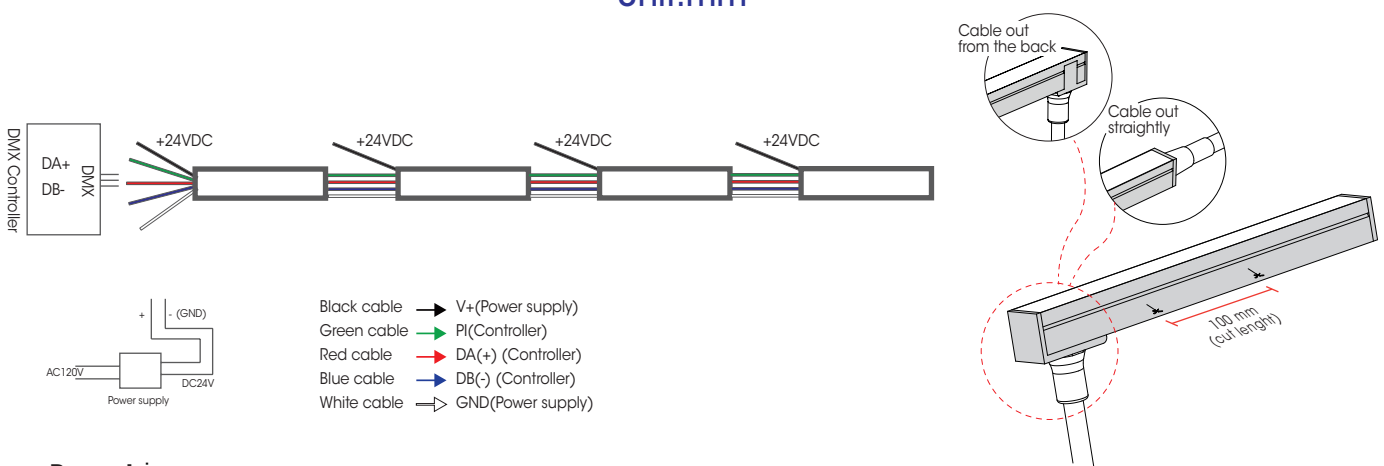

Remark:

1. To reduce signal interference, GND (white cable) is connected to the power supply, and can use another cable connected GND both on the controller and power supply.
2. If need signal writing, please connect the green cable, if don't need signal writing, no need connect the green cable.

INSTALLATION ACCESSORIES

Aluminium Buckle
17x18.5x25mm

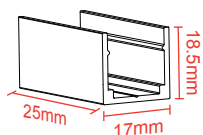

Lenght	25m
Buckle	4pcs
Screw	4pcs

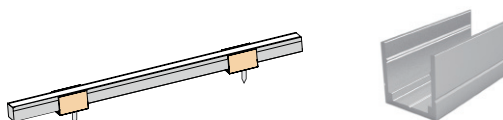

Screw
15x3.5mm

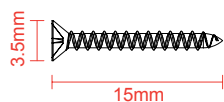

Aluminium profile
17x18.5x2440mm

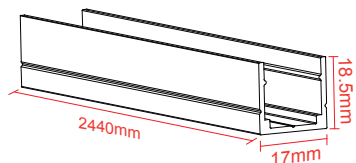

Lenght	2440m
Screw	8pcs

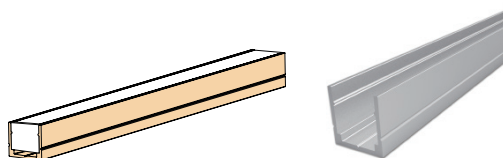

Screw
15x3.5mm

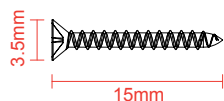

NEON LED STRIP INSTRUCTION AND CAUTION

Light profile

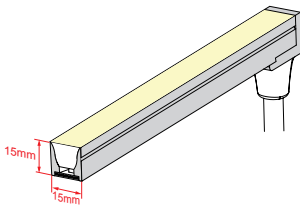

Correct bending way

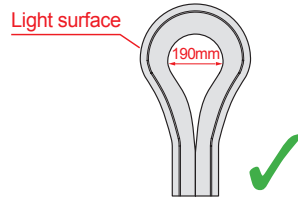

Face to the light surface
fold the strip, the minimum
bending diameter is 190mm.

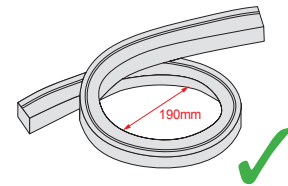

Light surface upwards, the
strip is bendable to right or
left naturally, the minimum
bending diameter is 190mm.

Bending direction profile

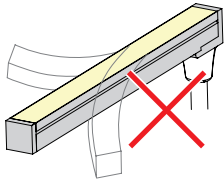
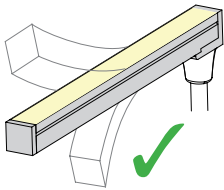

Incorrect bending way

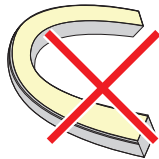

Face to the side surface,
(as the picture shows)
Do not bend downward to
damage the strip.

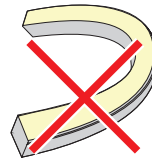

Face to the side surface,
(as the picture shows)
Do not bend upward to
damage the strip.



(as the picture shows)
please do not twist
the strip, or it will be
damaged.

PACKAGING

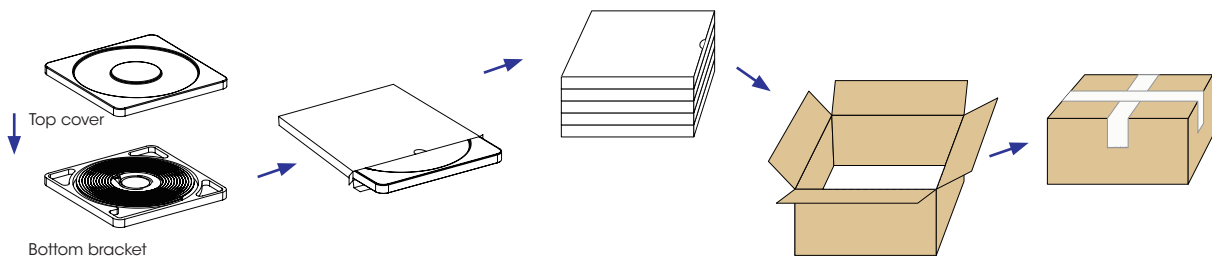

Light length	Plastic box dimension	White box dimension	Number of white box	Carton dimension
5m	416x416x24mm	421x422x26mm	5pcs	435x440x150mm