

# UL 26 - 12

## 12V 26AH

### STANDBY

# Ultracell®

'Quality in Every Language'

Image



Terminal Type

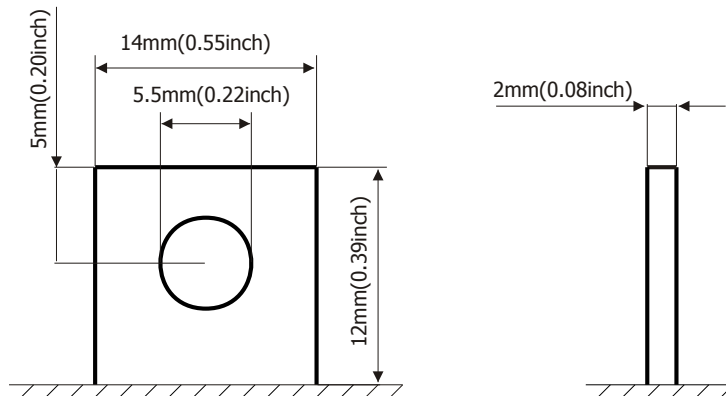

Dimensions

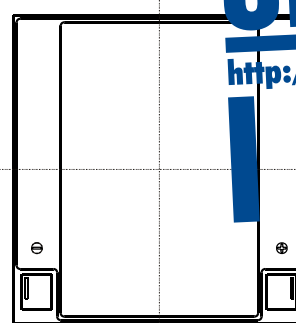
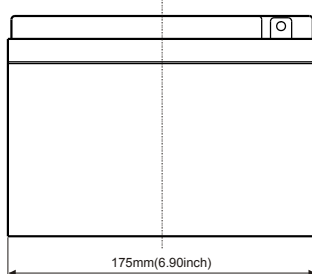
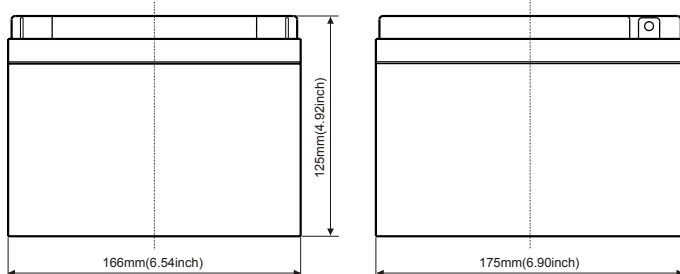

Ribera Elorrieta, 7C  
48015 - Bilbao  
Teléfono: 94 474 52 52  
Fax: 94 475 97 10  
E-mail: ukai@ukai.com

Specifications

Battery Model	UL 26 - 12			
Designed Floating Life	8 Years			
Capacity (25°C)	20HR (1.3A, 1.75V)	10HR (2.47A, 1.75V)	5HR (4.42A, 1.75V)	1HR (15.6A, 1.85V)
	26AH	24.7AH	22.1AH	15.6AH
Dimensions	Length	Width	Height	Total Height
	166mm	175mm	125mm	125mm
Approx. Weight	8.08Kg			
Internal Resistance	Fully Charged at 25°C 0.01 Ohm			
Self Discharge	3% of capacity declined per month at 25°C			
Capacity Affected by Temperature	40°C	25°C	0°C	-15°C
	102%	100%	85%	65%
Charge Voltage (25°C)	Cycle Use		Float Use	
	14.0-15.0V (-24mV/C), max. Current: 7.8A		13.6-13.8V (-18mV/C)	

Construction

Component ——— Raw material  
Positive ——— Lead dioxide  
Negative ——— Lead  
Container ——— ABS (Flame Retardent optional)  
Cover ——— ABS (Flame Retardent optional)

Sealed and maintenance free option

Sealant ——— Epoxy Resin  
Safety Valve ——— EPDR  
Terminal ——— Copper  
Separator ——— Fibre Glass  
Electrolyte ——— Sulphuric acid

Non-spillable construction design



**UKAI BILBAO**  
Ribera Elorrieta 7C  
48015 Bilbao  
Teléfono: 94 474 5252  
Fax: 94 475 9710  
e-mail: ukai@ukai.com

**UKAI BARCELONA**  
C/ Orient 78-84 1º 7ª (Ed. Inbisa)  
08011 St. Cugat del Vallés  
Teléfono: 93 284 0898  
Fax: 93 210 6765  
e-mail: ukaibcn@ukai.com

**UKAI MADRID**  
Avda Andalucía 2, 2ª planta local 211  
28702 San Sebastián de los Reyes  
Teléfono: 91 659 0328  
Fax: 91 659 0558  
e-mail: ukaimad@ukai.com

# UL 26 - 12

12V 26AH

STANDBY

# Ultrace//<sup>®</sup>

'Quality in Every Language'

## Charge Characteristic

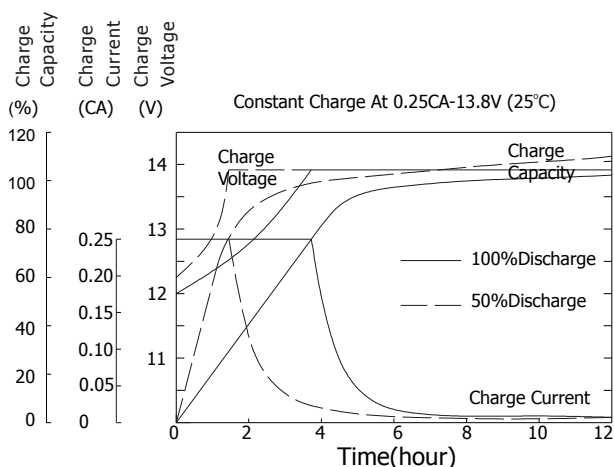

## Discharge Characteristic 25°C

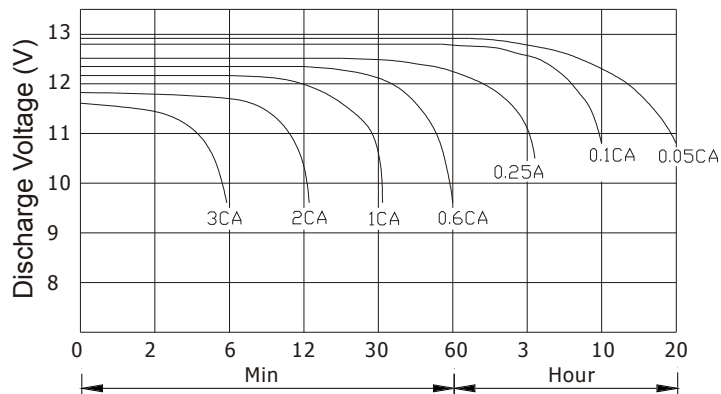

## Relationship of OCV and state of charge

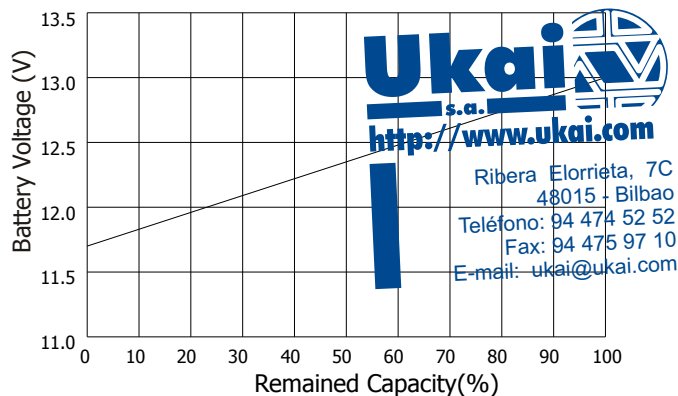

## Self Discharge Characteristics

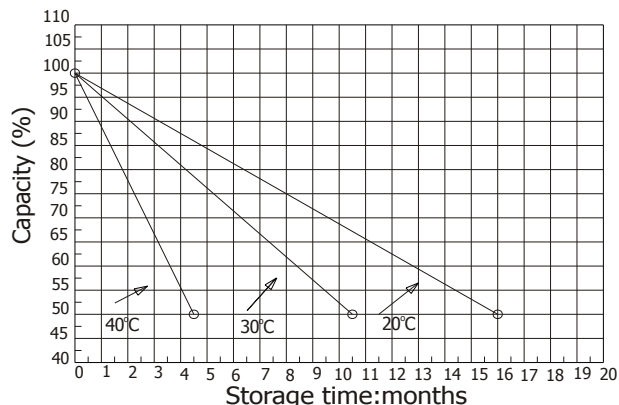

## Constant Current Discharge Ratings - amperes at 25°C

F.V / Time	5 MIN	10 MIN	15 MIN	30 MIN	1 HR	3 HR	5 HR	10 HR	20 HR
1.60 V	101.4	63.0	47.7	29.1	15.7	8.11	4.78	2.65	1.40
1.67 V	95.16	60.3	46.2	27.9	15.4	6.86	4.68	2.60	1.38
1.70 V	87.88	57.8	44.8	25.3	14.6	6.53	4.57	2.54	1.35
1.75 V	86.84	56.2	43.3	23.9	14.5	6.34	4.44	2.49	1.32
1.80 V	76.96	53.6	39.4	22.3	13.6	6.19	4.36	2.45	1.32
1.85 V	68.12	50.9	35.2	20.4	13.2	6.08	4.35	1.94	1.30

## Constant Power Discharge Ratings - watts at 25°C

F.V / Time	5 MIN	10 MIN	15 MIN	30 MIN	1 HR	3 HR	5 HR	10 HR	20 HR
1.60 V	208.0	135.2	104.0	60.3	33.8	13.2	8.94	5.04	2.65
1.67 V	201.2	132.1	102.4	59.3	33.4	13.1	8.89	5.04	2.65
1.70 V	192.9	130.0	99.84	58.2	33.1	13.0	8.88	4.99	2.60
1.75 V	181.5	124.8	96.72	56.7	32.5	12.9	8.85	4.99	2.60
1.80 V	157.6	115.4	92.56	55.1	31.5	12.6	8.74	4.88	2.55
1.85 V	148.7	107.1	88.40	52.5	30.8	12.4	8.66	4.88	2.55



**UKAI BILBAO**  
Ribera Elorrieta 7C  
48015 Bilbao  
Teléfono: 94 474 5252  
Fax: 94 475 9710  
e-mail: [ukai@ukai.com](mailto:ukai@ukai.com)

**UKAI BARCELONA**  
C/ Orient 78-84 1º 7ª (Ed. Inbisa)  
08011 St. Cugat del Vallés  
Teléfono: 93 284 0898  
Fax: 93 210 6765  
e-mail: [ukaibcn@ukai.com](mailto:ukaibcn@ukai.com)

**UKAI MADRID**  
Avda Andalucía 2, 2ª planta local 211  
28702 San Sebastián de los Reyes  
Teléfono: 91 659 0328  
Fax: 91 659 0558  
e-mail: [ukaimad@ukai.com](mailto:ukaimad@ukai.com)