

UL 7 - 6
6V 7AH
STANDBY

Ultracell®
 'Quality in Every Language'

Image



Terminal Type

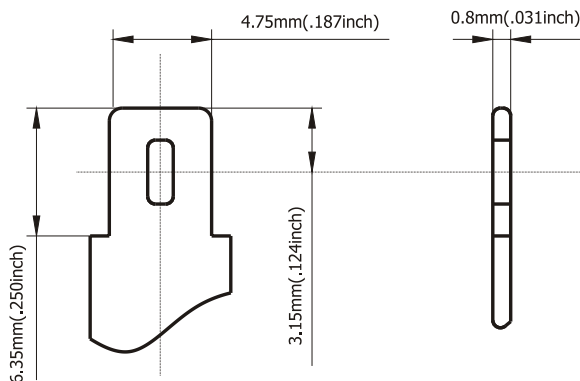

Dimensions

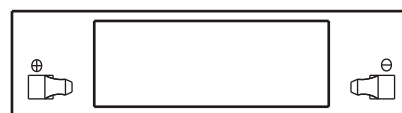
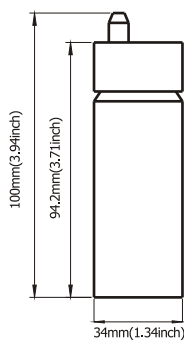
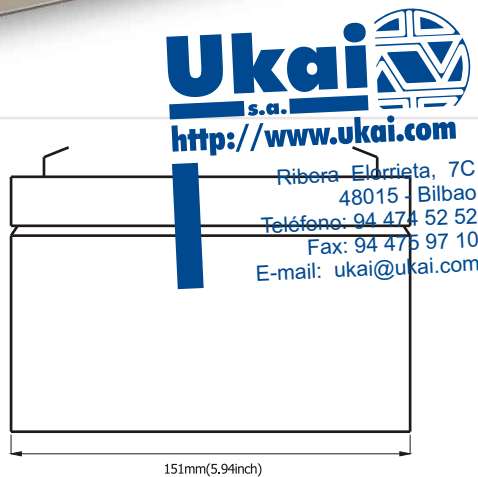

Specifications

Battery Model	UL 7 - 6			
Designed Floating Life	5 Years			
Capacity (25°C)	20HR (0.35A, 1.75V)	10HR (0.665A, 1.75V)	5HR (1.19A, 1.75V)	1HR (4.2A, 1.55V)
	7AH	6.65AH	5.95AH	4.2AH
Dimensions	Length	Width	Height	Total Height
	151mm	34mm	94.2mm	100mm
Approx. Weight	1.36Kg			
Internal Resistance	Fully Charged at 25°C 0.013 Ohm			
Self Discharge	3% of capacity declined per month at 25°C			
Capacity Affected by Temperature	40°C	25°C	0°C	-15°C
	102%	100%	85%	65%
Charge Voltage (25°C)	Cycle Use		Float Use	
	7.2-7.5V (-12mV/C), max. Current: 2.1A		6.75-6.9V (-9mV/C)	

Construction

Component	Raw material	Sealant	Epoxy Resin
Positive	Lead dioxide	Safety Valve	EPDR
Negative	Lead	Terminal	Copper
Container	ABS (Flame Retardent optional)	Separator	Fibre Glass
Cover	ABS (Flame Retardent optional)	Electrolyte	Sulphuric acid

Sealed and maintenance free option *Non-spillable construction design*



UKAI BILBAO
 Ribera Elorrieta 7C
 48015 Bilbao
 Teléfono: 94 474 5252
 Fax: 94 475 9710
 e-mail: ukai@ukai.com

UKAI BARCELONA
 C/ Orient 78-84 1º 7ª (Ed. Inbisa)
 08011 St. Cugat del Vallés
 Teléfono: 93 284 0898
 Fax: 93 210 6765
 e-mail: ukaibcn@ukai.com

UKAI MADRID
 Avda Andalucía 2, 2ª planta local 211
 28702 San Sebastián de los Reyes
 Teléfono: 91 659 0328
 Fax: 91 659 0558
 e-mail: ukaimad@ukai.com

UL 7 - 6

6V 7AH

STANDBY

Ultracell®

'Quality in Every Language'

Charge Characteristic

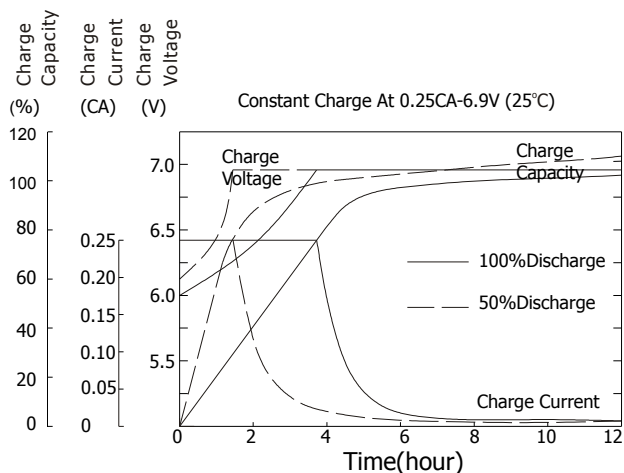

Discharge Characteristic 25°C

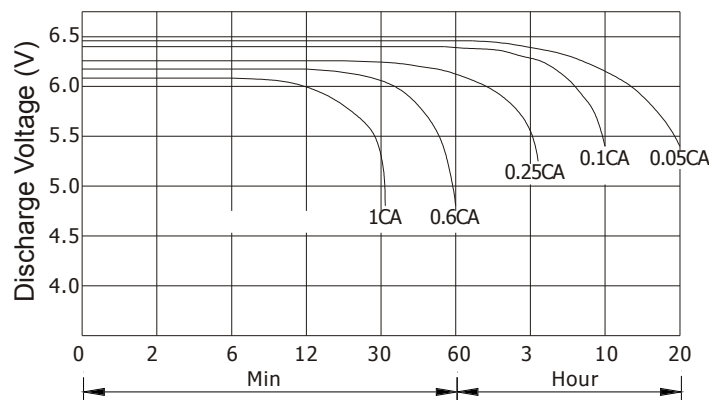

Relationship of OCV and state of charge

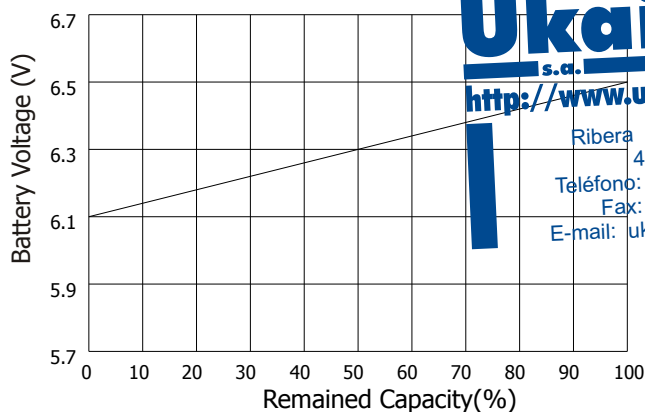

Ukai
s.a.
<http://www.ukai.com>
Ribera Elorrieta, 7C
48015 - Bilbao
Teléfono: 94 474 52 52
Fax: 94 475 97 10
E-mail: ukai@ukai.com

Self Discharge Characteristics

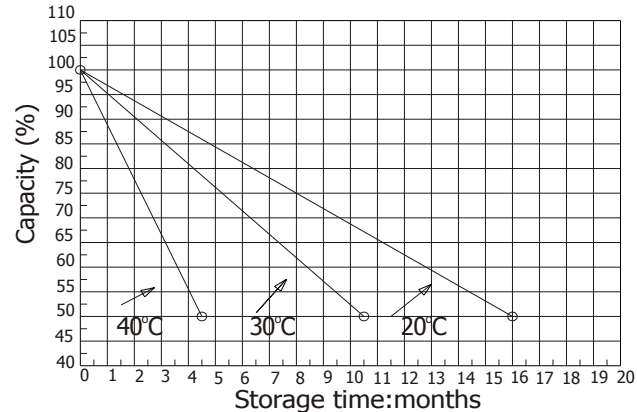

Constant Current Discharge Ratings - amperes at 25°C

F.V / Time	5 MIN	10 MIN	15 MIN	30 MIN	1 HR	3 HR	5 HR	10 HR	20 HR
1.60 V	27.3	17.1	12.9	7.83	4.20	2.01	1.29	0.71	0.39
1.67 V	25.6	16.3	12.4	7.48	4.15	1.89	1.25	0.70	0.39
1.70 V	23.4	15.7	12.2	6.94	4.01	1.75	1.22	0.68	0.36
1.75 V	23.0	15.2	11.8	6.59	3.79	1.68	1.19	0.67	0.35
1.80 V	20.5	14.5	10.7	6.09	3.50	1.59	1.18	0.67	0.34
1.85 V	18.2	13.8	9.6	5.60	3.21	1.55	1.13	0.66	0.34

Constant Power Discharge Ratings - watts at 25°C

F.V / Time	5 MIN	10 MIN	15 MIN	30 MIN	1 HR	3 HR	5 HR	10 HR	20 HR
1.60 V	56.1	36.5	28.0	16.1	9.10	3.55	2.41	1.34	0.71
1.67 V	54.3	35.8	27.5	16.0	9.01	3.53	2.41	1.34	0.71
1.70 V	51.9	34.8	26.9	15.8	8.90	3.50	2.40	1.33	0.70
1.75 V	48.9	33.7	26.1	15.4	8.75	3.47	2.38	1.32	0.70
1.80 V	42.2	31.1	24.9	14.8	8.49	3.40	2.34	1.31	0.69
1.85 V	40.2	30.2	23.8	14.2	8.29	3.34	2.21	1.31	0.69

Ukai
s.a.
<http://www.ukai.com>

UKAI BILBAO
Ribera Elorrieta 7C
48015 Bilbao
Teléfono: 94 474 5252
Fax: 94 475 9710
e-mail: ukai@ukai.com

UKAI BARCELONA
C/ Orient 78-84 1º 7ª (Ed. Inbisa)
08011 St. Cugat del Vallés
Teléfono: 93 284 0898
Fax: 93 210 6765
e-mail: ukaibcn@ukai.com

UKAI MADRID
Avda Andalucía 2, 2ª planta local 211
28702 San Sebastián de los Reyes
Teléfono: 91 659 0328
Fax: 91 659 0558
e-mail: ukaimad@ukai.com